

# B38 Series Regulator

## Commercial and Industrial Regulator



Appropriate for large capacity commercial and industrial uses where inches of water column or pounds delivery is desired such as utility services, gas engines, burner trains, furnace, and boilers. The rapid response of the B38 is particularly well-suited for application where sudden on/off loads cause shock problems.

## Description

- » B38R – Spring loaded, self operating, high capacity regulator that provides exceptional over pressure protection by utilizing a 2-1/2" npt internal relief valve and ven.
- » B38N – This model is the non-relief version of the B38 and can be used on low or intermediate inlet pressures where over pressure protection is not needed. Comes with 1" npt vent opening
- » B38M – This is a monitor version of the B38 series regulator. The B38M has an "O" ring seal, a closed throat and a control line that allows it to monitor the downstream pressure in case of operator monitor failure
- » B38IMR – This regulator comes equipped with an internal monitor device as well as a backup internal relief valve to ensure that overpressure protection is maintained by two safety devices. This version is appropriate for applications

where an added level of overpressure protection is desired

- » B38N – The B38IMN regulator is equipped with an internal monitor orifice and no internal relief valve. This version is appropriate for applications where overpressure protection is desired without relieving gas to the atmosphere
- » B38IMRV – The B38IMRV is equipped with an internal monitoring device as well as a backup internal relief valve and a vent hole in the sliding orifice. The vent hole allows the relief valve to weep gas to the atmosphere and signaling a problem with the regulator in the event the internal monitor is operating

## Benefits

- » Controlled breather orifice size eliminates pulsation and provides normal action at low flows

- » Large Capacities achievable with orifices as big as 1-3/8"
- » Unmatched overpressure protections with an Internal Monitor plus a internal relief valve all using only one easy to install valve body
- » Fast response protects equipment from shock damage
- » Internal Monitor is designed to meet D.O.T. safety standards

## Features

- » Interchangeable orifice
- » 78 square inches of diaphragm area
- » Spring internal relief valve assembly
- » Field interchangeable adjustment spring
- » Wide range of valve body sizes including NPT and flanged connections
- » 2-1/2" relief vent provides exceptional internal relief performance; replaces the need for external relief valves

# B38 SERIES COMMERCIAL REGULATOR

## SHIPPING WEIGHT

One regulator per box    Box weight 2" NPT: 25 lbs.    2" Flanged: 35 lbs.    3" Flanged: 45 lbs.

## B38 DIMENSIONS (INCHES)

Valve Body	Models	A	B	C	D	E	F	G	H	R
1/1/2 or 2 NPT	N, DN, MN, IMN	7-1/2	3-3/4	10-5/8	12-7/8	4-5/16	9-5/8	2-3/16	6-3/4	3-3/8
	R, DR, MR, IMR, IMRV	7-1/2	3-3/4	10-5/8	13	5	9-5/8	2-3/16	6-3/4	3-3/8
2 Flanged	N, DN, MN, IMN	10	5	10-5/8	12-7/8	4-5/16	9-5/8	2-3/16	6-1/2	3-5/16
	R, DR, MR, IMR, IMRV	10	5	10-5/8	13	5	9-5/8	2-3/16	6-1/2	3-5/16
3 Flanged	N, DN, MN, IMN	10	5	10-5/8	12-7/8	4-5/16	9-5/8	2-3/16	7-3/8	4-3/16
	R, DR, MR, IMR, IMRV	10	5	10-5/8	13	5	9-5/8	2-3/16	7-3/8	4-3/16

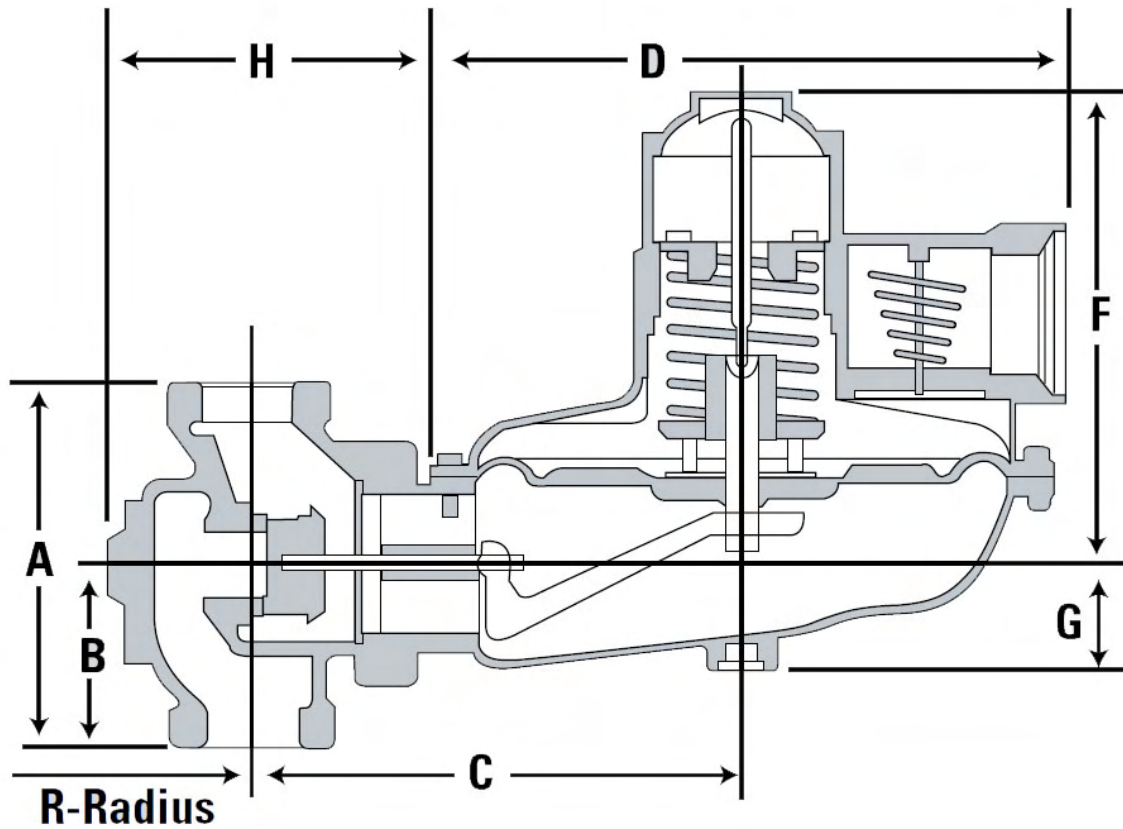

# OPERATIONAL SCHEMATIC

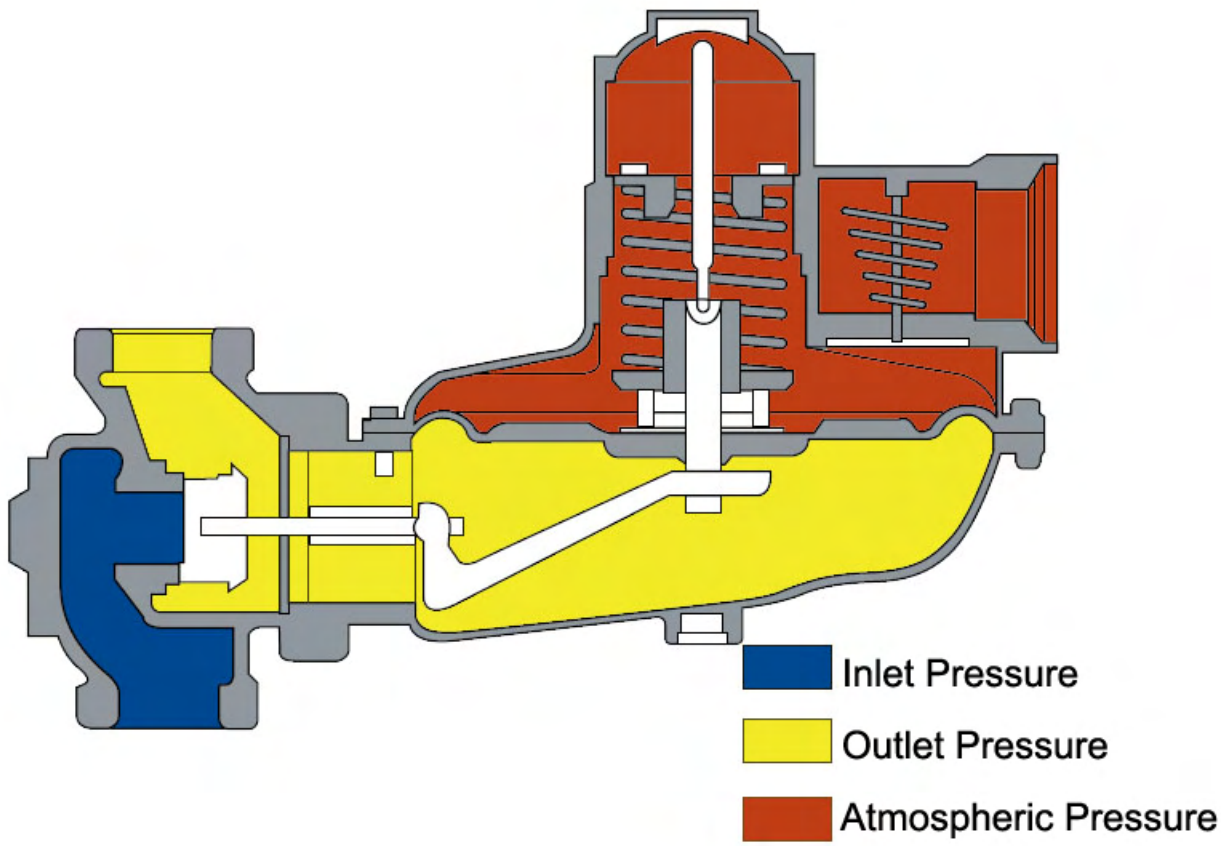

Note Valve shown in closed position.

## B38 N, R, M, & D SPRING DATA, SPRING COLOR OUTLET PRESSURE RANGE

Orifice Size (inches)	Inlet Pressure (PSIG)	Spring Color	Outlet Pressure		Orifice Size (inches)	Inlet Pressure (PSIG)	Spring Color	Outlet Pressure	
			Min.	Max.				Min.	Max.
1/4	25 PSIG	Orange	2.3" w.c.	3.7" w.c.	3/4	25 PSIG	Orange	4.2" w.c.	6.2" w.c.
		Brown	3.8" w.c.	6.2" w.c.			Brown	4.3" w.c.	6.2" w.c.
		Green	4.2" w.c.	7.2" w.c.			Green	6.3" w.c.	9.0" w.c.
		Black	7.3" w.c.	12.0" w.c.			Black	9.4" w.c.	15.0" w.c.
		Purple	12.3" w.c.	20.3" w.c.			Purple	13.7" w.c.	22.3" w.c.
		Blue	0.5 PSIG	0.9 PSIG			Blue	17.1" PSIG	1.1 PSIG
		Blue/white	1.0 PSIG	1.6 PSIG			Blue/white	1.0 PSIG	1.6 PSIG
		Silver	1.3 PSIG	2.0 PSIG			Silver	1.4 PSIG	2.5 PSIG
		Silver/red	1.6 PSIG	2.5 PSIG			Silver/red	1.8 PSIG	3.0 PSIG
		Yellow	2.7 PSIG	4.5 PSIG			Yellow	2.5 PSIG	4.2 PSIG
		Red nested	2.5 PSIG	6.5 PSIG			Red nested	1.9 PSIG	6.8 PSIG
		White nested	3.0 PSIG	7.3 PSIG			White nested	2.0 PSIG	7.8 PSIG
		3/8	25 PSIG	Orange			3.3" w.c.	4.5" w.c.	1
Brown	4.5" w.c.			6.2" w.c.	Brown	5.4" w.c.	7.8" w.c.		
Green	5.5" w.c.			7.8" w.c.	Green	7.5" w.c.	10.0" w.c.		
Black	8.1" w.c.			13.6" w.c.	Black	10.9" w.c.	16.1" w.c.		
Purple	12.4" w.c.			21.2" w.c.	Purple	15.0" w.c.	23.8" w.c.		
Blue	14.1" w.c.			27.0" w.c.	Blue	18.3" w.c.	1.2 w.c.		
Blue/white	0.9 PSIG			1.6 PSIG	Blue/white	1.0 PSIG	1.7 PSIG		
Silver	1.3 PSIG			2.5 PSIG	Silver	1.5 PSIG	2.7 PSIG		
Silver/red	1.7 PSIG			2.9 PSIG	Silver/red	1.9 PSIG	3.1 PSIG		
Yellow	2.3 PSIG			4.2 PSIG	Yellow	2.5 PSIG	4.2 PSIG		
Red nested	1.8 PSIG			6.8 PSIG	Red nested	2.1 PSIG	6.9 PSIG		
White nested	2.0 PSIG			7.7 PSIG	White nested	2.1 PSIG	7.8 PSIG		
1/2	25 PSIG			Orange	2.3" w.c.	4.5" w.c.	1-1/4	10 PSIG	
		Brown	3.5" w.c.	5.9" w.c.	Brown	5.2" w.c.			7.3" w.c.
		Green	5.0" w.c.	8.2" w.c.	Green	5.8" w.c.			9.7" w.c.
		Black	8.5" w.c.	14.0" w.c.	Black	9.4" w.c.			14.9" w.c.
		Purple	12.7" w.c.	21.4" w.c.	Purple	13.5" w.c.			22.2" w.c.
		Blue	16.2" w.c.	1.0 PSIG	Blue	17.3" w.c.			29.8" PSIG
		Blue/white	1.0 PSIG	1.6 PSIG	Blue/white	26.9" w.c.			1.6 PSIG
		Silver	1.4 PSIG	2.5 PSIG	Silver	1.4 PSIG			2.6 PSIG
		Silver/red	1.7 PSIG	3.0 PSIG	Silver/red	1.8 PSIG			3.0 PSIG
		Yellow	2.5 PSIG	4.2 PSIG	Yellow	2.5 PSIG			4.1 PSIG
		Red nested	1.8 PSIG	6.7 PSIG	Red nested	1.9 PSIG			6.6 PSIG
		White nested	2.0 PSIG	7.7 PSIG	White nested	2.1 PSIG			7.8 PSIG

Orifice Size (inches)	Inlet Pressure (PSIG)	Spring Color	Outlet Pressure		Orifice Size (inches)	Inlet Pressure (PSIG)	Spring Color	Outlet Pressure	
			Min.	Max.				Min.	Max.
5/8	25 PSIG	Orange	3.8" w.c.	4.5" w.c.	1-3/8	10 PSIG	Orange	3.0" w.c.	4.6" w.c."
		Brown	5.4" w.c.	7.3" w.c.			Brown	4.0" w.c.	6.4" w.c.
		Green	6.4" w.c.	9.2" w.c.			Green	5.0" w.c.	8.0" w.c.
		Black	9.3" w.c.	14.8" w.c.			Black	9.6" w.c.	15.3" w.c.
		Purple	12.7" w.c.	21.4" w.c.			Purple	13.5" w.c.	22.2" w.c.
		Blue	15.9" w.c.	29.5" w.c.			Blue	17.8" w.c	30.2" w.c.
		Blue/white	0.9 PSIG	1.6 PSIG			Blue/white	27.4" w.c.	1.7 PSIG
		Silver	1.1 PSIG	2.6 PSIG			Silver	1.4 PSIG	2.5 PSIG
		Silver/red	1.7 PSIG	2.9 PSIG			Silver/red	1.9 PSIG	3.0 PSIG
		Yellow	2.5 PSIG	4.1 PSIG			Yellow	2.5 PSIG	4.2 PSIG
		Red nested	1.8 PSIG	6.6 PSIG			Red nested	2.0 PSIG	6.7 PSIG
White nested	2.0 PSIG	7.7 PSIG	White nested	2.1 PSIG	7.8 PSIG				

## ORIFICE DATA, WIDE OPEN COEFFICIENTS AND MAXIMUM PRESSURE DATA

Orifice Size (in.)	K-Factor (SCFH/ PSI)	Maximum Operating Inlet Pressure								Maximum Emergency Inlet Pressure		Maximum Emergency Outlet Pressure (Gas Containment)	
		<1 PSIG Outlet N&R Models		<1 PSIG Outlet D&M Models		<1 PSIG Outlet IMN&IMR Models		>1 PSIG Outlet All Models		All Models All outlet pressures		All Models All outlet pressures	
		PSIG	Bar	PSIG	Bar	PSIG	Bar	PSIG	Bar	PSIG	Bar	PSIG	Bar
1/4"	125	125	(8.6)	175	(12.1)	---	---	175	(12.1)	300	(20.6)	30	(2.0)
3/8"	305	125	(8.6)	175	(12.1)	---	---	175	(12.1)	300	(20.6)	30	(2.0)
3/8" IM	265	---	---	---	---	125	(8.6)	175	(8.6)	300	(20.6)	30	(2.0)
1/2"	500	125	(8.6)	125	(8.6)	---	---	175	(12.1)	300	(20.6)	30	(2.0)
1/2" IM	410	---	---	---	---	125	(8.6)	175	(8.6)	300	(20.6)	30	(2.0)
5/8"	700	75	(5.2)	125	(8.6)	---	---	150	(10.3)	300	(20.6)	30	(2.0)
5/8" IM	667	---	---	---	---	60	(4.1)	150	(4.1)	300	(20.6)	30	(2.0)
3/4"	1000	60	(4.1)	125	(8.6)	---	---	150	(10.3)	300	(20.6)	30	(2.0)
3/4" IM	750	---	---	---	---	60	(4.1)	150	(4.1)	300	(20.6)	30	(2.0)
1"	1500	65	(4.1)	100	(6.9)	---	---	100	(6.9)	170	(11.7)	30	(2.0)
1" IM	925	---	---	---	---	30	(2.1)	100	(2.1)	170	(11.7)	30	(2.0)
1-1/4"	1700	40	(2.8)	75	(5.2)	---	---	75	(5.2)	125	(8.6)	30	(2.0)

Outlet Pressure Change as a Result of 10 PSIG Inlet Pressure Change Orifice Size (inches)								
Spring Color	1/4	3/8	1/2	5/8	3/4	1	1-1/4	1-3/8
	w.c.							
Orange	0.1" w.c.	0.2" w.c.	0.3" w.c.	0.7" w.c.	0.9" w.c.	1.1" w.c.	1.8" w.c.	1.1" w.c.
Brown	0.1" w.c.	0.3" w.c.	0.3" w.c.	0.4" w.c.	0.9" w.c.	1.1" w.c.	1.4" w.c.	1.2" w.c.
Green	0.1" w.c.	0.3" w.c.	0.4" w.c.	0.6" w.c.	0.7" w.c.	1.2" w.c.	2.0" w.c.	1.4" w.c.
Green/white	0.1" w.c.	0.3" w.c.	0.4" w.c.	0.6" w.c.	0.7" w.c.	1.2" w.c.	2.0" w.c.	1.4" w.c.
Black	0.1" w.c.	0.3" w.c.	0.4" w.c.	0.6" w.c.	0.7" w.c.	1.6" w.c.	2.1" w.c.	2.3" w.c.
Purple	0.1" w.c.	0.3" w.c.	0.4" w.c.	0.6" w.c.	0.8" w.c.	1.7" w.c.	1.8" w.c.	2.0" w.c.
Blue	0.2" w.c.	0.4" w.c.	0.6" w.c.	0.6" w.c.	1.0" w.c.	1.7" w.c.	2.0" w.c.	2.8" w.c.
Blue/white	0.01 PSIG	0.01 PSIG	0.04 PSIG	0.02 PSIG	0.03 PSIG	0.06 PSIG	0.08 PSIG	0.11 PSIG
Silver	0.01 PSIG	0.01 PSIG	0.04 PSIG	0.06 PSIG	0.03 PSIG	0.07 PSIG	0.12 PSIG	0.13 PSIG
Silver/red	0.01 PSIG	0.02 PSIG	0.03 PSIG	0.04 PSIG	0.03 PSIG	0.08 PSIG	0.10 PSIG	0.11 PSIG
Yellow	0.01 PSIG	0.03 PSIG	0.04 PSIG	0.03 PSIG	0.05 PSIG	0.09 PSIG	0.12 PSIG	0.15 PSIG
Red nested	0.02 PSIG	0.03 PSIG	0.05 PSIG	0.05 PSIG	0.10 PSIG	0.13 PSIG	0.19 PSIG	0.23 PSIG
White nested	0.01 PSIG	0.03 PSIG	0.05 PSIG	0.05 PSIG	0.13 PSIG	0.16 PSIG	0.24 PSIG	0.28 PSIG

## OPERATING TEMPERATURE RANGE

• -20°F to 150°F

## ADDITIONAL SPECIFICATIONS

### Available Vent Sizes

1" NPT on non-internal relief (N) models only  
 2-1/2" NPT (standard) on internal relief (R) models only  
 (Optional) 2" NPT **Warning** The 2" relief size will reduce relief capacity.

### Loading Ring Position

For outlet pressure >1 PSIG: 0°  
 For outlet pressure <1 PSIG: 40°

### Other Available Options

Seal wire to indicate unapproved tampering  
 1/8" pipe plug tap on upstream side of valve body

## CONSTRUCTION

ROOTS Regulators takes pride in delivering products with the utmost concern for safety, quality, and customer satisfaction.

### Construction materials

Valve body	High tensile strength cast iron (ASTM A-126, Class A)
Orifice (Standard and IM)	Brass (ASTM B16, Alloy 360)
Valve seat	Buna-N
Valve stem	Plated Steel (AISI 1215)
Lever pin	Stainless steel (Type 303)
Lever	Zinc and dichromate plated steel (AISI C1010)
Upper diaphragm plate	Zinc and dichromate plated steel (14 gage steel)
Lower diaphragm plate	Die cast aluminum (ASTM B85 Alloy SC84A)
Diaphragm	Buna-N and nylon reinforcing fabric
Vent valve/seat	Neoprene
Vent screen	Stainless steel (16 mesh)
Adjustment ferrule	Die cast aluminum (ASTM CS43A)
Seal cap	Die cast aluminum (ASTM CS43A)
Diaphragm case	Die cast aluminum (ASTM B85-Alloy SC84A)

## VALVE BODY SIZES (INCHES)

Inlet	Outlet	NPT	Flanged
1-1/2	1-1/2	X	---
2	2	X	X
3	3	---	X

Note X indicates the valve body is available in that configuration.

# CORRECTION FACTORS FOR NON-NATURAL GAS APPLICATIONS

The B38 may be used to control gases other than natural gas. To determine the capacity for gases other than natural gas, multiply the values within the capacity tables by a correction factor. The table below lists the correction factors for some of the more common gases:

Gas Type	Specific Gravity	Correction Factor (CF)
Air	1.00	0.77
Butane	2.01	0.55
Carbon Dioxide (Dry)	1.52	0.63
Carbon Monoxide (Dry)	0.97	0.79
Natural Gas	0.60	1.00
Nitrogen	0.97	0.79
Propane	1.53	0.63
Propane-Air-Mix	1.20	0.71

To calculate the correction factor for gases not listed in the table above, use the gases' specific gravity and insert it in the formula listed below:

$$\sqrt{\frac{SG_1}{SG_2}}$$

Correction Factor (CF) =

Where:

SG1 = Specific gravity of the gas in which the capacity is published.

SG2 = Specific gravity of the gas to be controlled.

## Wide Open Flow Calculations

For wide-open orifice flow calculations use the following equations:

For  $\frac{P_1}{P_2} < 1.89$  use:  $Q = K\sqrt{P_2(P_1 - P_2)}$

For  $\frac{P_1}{P_2} > 1.89$  use:  $Q = \frac{KP_1}{2}$

Where: P<sub>1</sub> = Absolute Inlet Pressure (PSIA)

P<sub>2</sub> = Absolute Outlet Pressure (PSIA)

Q = Flow Rate (SCFH)

K = Orifice Coefficient (SCFH/PSI)



# B38 SERIES COMMERCIAL REGULATOR, MODELS N, R, M, AND D

7" w.c. (17 mbar) Capacity Table (1" Droop\*), 2" Inlet/Outlet

Capacities in SCFH (m<sup>3</sup>/hr) of 0.6 S.G. gas; base conditions of 14.7 PSIA and 60° F.

Typical Capacity Info.		Loading Ring Setting	Inlet Pressure		Orifice Size															
			PSIG	Bar	1/4"	3/8"	1/2"	5/8"	3/4"	1"	1-1/4"	1-3/8"								
<b>Manufacturer</b>	ROOTS Regulators	0°	12"	0.030					300	(8.4)	330	(9.3)	570	(16.0)	1250	(35.0)	1750	(49.0)	2000	(56.0)
		40°	12" w.c.																	
<b>Type and model</b>	B38R	0°	14"	0.035					310	(8.9)	400	(11.3)	650	(18.2)	1650	(46.2)	2100	(59.4)	2600	(73.6)
		40°	14" w.c.																	
<b>Inlet size</b>	2" NPT	0°	16"	0.040					320	(9)	450	(12.6)	700	(19.8)	1800	(50.4)	2600	(73.6)	2800	(79.3)
<b>Outlet size</b>	2" NPT	40°	16" w.c.																	
<b>Position</b>	11	0°	18"	0.045	260	(7.3)	290	(8.1)	330	(9.2)	500	(14.0)	1250	(35.0)	2000	(56.0)	2800	(79.3)	2900	(81.2)
<b>Loading ring setting</b>	0°	40°	18" w.c.																	
		0°	21"	0.052	290	(8.1)	310	(8.9)	450	(12.6)	720	(20.2)	1500	(42.0)	2500	(70)	2900	(82.1)	3300	(93.4)
		40°	21" w.c.		290	(8.1)	300	(8.4)	450	(17.4)	530	(14.8)	1450	(40.6)	2200	(61.6)	2900	(82.1)	3200	(90.6)
		0°	24"	0.060	330	(9.2)	370	(10.4)	550	(15.4)	770	(21.6)	1600	(45.3)	2700	(76.4)	3300	(93.4)	3700	(104.7)
		40°	24" w.c.		330	(9.2)	350	(9.8)	530	(19.6)	650	(18.2)	1030	(29.2)	2500	(70.8)	3100	(87.8)	3300	(93.4)
		0°	1	0.069	400	(11.2)	450	(12.64)	600	(17)	1300	(36.8)	1700	(48.1)	2800	(79.3)	3400	(96.3)	3500	(99.1)
		40°	1		400	(11.2)	450	(12.64)	600	(17)	1050	(29.7)	1550	(43.9)	2600	(73.6)	3200	(89.6)	3400	(96.3)
		0°	2	0.14	620	(17.4)	1100	(30.8)	1600	(44.8)	2150	(60.9)	3000	(84.9)	4100	(116.1)	5700	(161.4)	5850	(165.6)
		40°	2		620	(17.4)	1100	(30.8)	1500	(42.0)	1900	(53.8)	2600	(73.6)	3300	(93.4)	3700	(104.7)	4400	(124.6)
		0°	3	0.21	770	(21.6)	1450	(40.6)	2200	(62.3)	2950	(83.5)	4000	(113.3)	5600	(158.6)	7600	(215.2)	7700	(218)
		40°	3		770	(21.6)	1450	(40.6)	2000	(56.0)	2600	(73.6)	3700	(104.7)	4200	(118.9)	5000	(141.6)	5900	(167.1)
		0°	5	0.35	1015	(28.4)	1900	(53.8)	3200	(90.6)	4300	(121.8)	5850	(165.6)	8000	(226.5)	10500	(297.3)	10800	(305.8)
		40°	5		1015	(28.4)	1900	(53.8)	2900	(82.1)	3800	(107.6)	5300	(150.1)	5600	(158.6)	6600	(186.9)	9400	(266.2)
		0°	10	0.69	1530	(43.3)	3150	(89)	5000	(141.5)	6900	(195.4)	9300	(263.3)	12800	(362.4)	17000	(481.4)	17700	(501.2)
		40°	10		1530	(43.3)	3150	(89)	4700	(133.1)	6100	(172.7)	8700	(246.4)	9300	(263.3)	9800	(277.5)	14500	(410.6)
		40°	20	1.38	2180	(61.7)	4850	(137.3)	7100	(201)	10150	(287.4)	12500	(354)	12600	(356.8)	12800	(362.5)	20000	(566.6)
		40°	30	2.07	2810	(79.6)	5500	(155.7)	9000	(254.8)	12000	(340)	13250	(375.2)	13750	(389.4)	14200	(402.1)		
		40°	40	2.76	3450	(97.7)	7000	(198.2)	11500	(325.6)	15500	(439)	16500	(467.2)	17000	(481.4)	20000	(566.6)		
		40°	50	3.45	4280	(121.2)	8200	(232.2)	12500	(354)	16000	(453.1)	18000	(509.7)	19010	(540.8)				
		40°	60	4.14	4700	(133.1)	11000	(311.5)	13400	(379.4)	20000	(566.6)	20000	(566.6)	20000	(566.6)				
		40°	70	4.83	5450	(154.3)	10700	(303)	14445	(409)	20000	(566.6)								
		40°	80	5.52	6210	(175.8)	11300	(319.9)	15820	(448)										
		40°	90	6.21	6715	(190.0)	11210	(317.4)	16520	(467.8)										
		40°	100	6.90	7070	(200.2)	17150	(485.6)	20000	(566.6)										
		40°	125	8.63	7950	(225.1)	20000	(566.6)	20000	(566.6)										
Inlet Effect A (in. w.c.)					0.1	0.3	0.4	0.6	0.7	1.2	2.0	2.4								
Lock Up B (in. w.c.)					0.3	0.3	0.5	1.0	1.1	1.3	1.6	2.2								

Notes:

A. Change in outlet pressure for 10 PSIG inlet pressure change.

B. Outlet pressure increase required for lockup.

\*Individual regulator performance may vary from data shown.

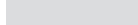
 Do not operate orifice in shaded inlet pressure area.  
 Inlet pressure is too low to deliver 7" w.c. (17.5 mbar).

# B38 SERIES COMMERCIAL REGULATOR, MODELS N, R, M, AND D

7" w.c. (17 mbar) Capacity Table (1" Droop\*), 1-1/2" Inlet/Outlet

Capacities in SCFH (m<sup>3</sup>/hr) of 0.6 S.G. gas; base conditions of 14.7 PSIA and 60°

Typical Capacity Info.		Loading Ring Setting	Inlet Pressure		Orifice Size																
			PSIG	Bar	1/4"	3/8"	1/2"	5/8"	3/4"	1"	1-1/4"	1-3/8"									
<b>Manufacturer</b>	ROOTS Regulators	0°	12" w.c.	0.030					290	(8.1)	330	(9.3)	570	(16.0)	1250	(35.0)	1750	(49.0)	2000	(56.0)	
		40°																			
<b>Type and model</b>	B38R	0°	14" w.c.	0.035					300	(8.4)	400	(11.3)	650	(18.2)	1650	(46.2)	2100	(59.4)	2600	(73.6)	
		40°																			
<b>Inlet size</b>	1-1/2" NPT	0°	16" w.c.	0.040					310	(8.9)	450	(12.6)	700	(19.8)	1800	(50.4)	2600	(73.6)	2800	(79.3)	
<b>Outlet size</b>	1-1/2" NPT	40°																			
<b>Position</b>	11	0°	18" w.c.	0.045		240	(6.8)	250	(7.0)	320	(9.0)	480	(13.6)	1200	(34.0)	1910	(54.1)	2725	(77.2)	2860	(81.0)
		40°																			
<b>Loading ring setting</b>	0°	0°	21" w.c.	0.052		250	(7.0)	290	(8.1)	410	(11.6)	690	(19.5)	1410	(39.9)	2400	(68.0)	2810	(79.6)	3175	(89.9)
		40°				235	(6.7)	280	(7.9)	390	(11.0)	510	(14.4)	1300	(36.8)	2100	(59.4)	2810	(79.6)	2900	(82.1)
		0°	24" w.c.	0.060		300	(8.4)	340	(9.6)	520	(14.7)	725	(20.5)	1524	(43.2)	2610	(73.9)	3125	(89.5)	3600	(101.9)
		40°				300	(8.4)	320	(9.0)	495	(14)	725	(20.5)	1400	(39.6)	2400	(68.0)	2925	(82.8)	3250	(92)
		0°	1	0.069		315	(8.9)	365	(10.3)	550	(15.6)	1225	(34.7)	1600	(45.3)	2725	(77.2)	3290	(93.2)	3725	(105.5)
		40°				315	(8.9)	365	(10.3)	550	(15.6)	1200	(34.0)	1550	(43.9)	2550	(72.2)	3000	(85)	3310	(93.7)
		0°	2	0.14		600	(17.0)	1000	(28.3)	1525	(43.1)	2050	(58.0)	2910	(82.4)	4025	(114)	5500	(155.7)	5780	(163.7)
		40°				600	(17.0)	1000	(28.3)	1400	(39.6)	1825	(51.7)	2400	(68.0)	3175	(89.9)	3500	(99.1)	5000	(141.6)
		0°	3	0.21		680	(21.6)	1380	(39.0)	2130	(60.3)	2500	(70.8)	3500	(99.1)	5300	(150.0)	6800	(192.5)	7550	(213.8)
		40°				680	(21.6)	1380	(39.0)	1900	(53.8)	2410	(68.2)	3100	(87.8)	4000	(113.3)	4500	(127.4)	5700	(161.4)
		0°	5	0.35		900	(25.5)	1800	(50.9)	3100	(87.8)	4120	(116.7)	5600	(158.6)	7500	(212.3)	10200	(288.8)	10400	(294.5)
		40°				900	(25.5)	1800	(50.9)	2800	(79.2)	3500	(99.1)	5100	(144.4)	5420	(153.5)	6400	(181.2)	8900	(252)
		0°	10	0.69		1450	(41.0)	2900	(82.1)	4750	(134.5)	6120	(173.3)	8900	(252.0)	11800	(334.1)	15800	(447.4)	16300	(461.6)
		40°				1450	(41.0)	2900	(82.1)	4400	(124.5)	6120	(173.3)	8500	(240.7)	10600	(300.1)	12000	(339.8)	14000	(396.4)
		40°	20	1.38	1900	(53.8)	4000	(113.3)	6300	(174.8)	9900	(280.3)	12990	(367.8)	13100	(371.0)	14200	(402.1)	20000	(566.6)	
		40°	30	2.07	2750	(77.9)	5400	(152.9)	8900	(252.0)	11600	(328.5)	13200	(373.8)	13500	(382.3)	15100	(427.6)			
		40°	40	2.76	3000	(84.9)	6600	(186.9)	11000	(311.5)	15000	(424.8)	16300	(461.6)	16800	(475.7)	20000	(566.6)			
		40°	50	3.45	3800	(107.6)	7800	(220.9)	12000	(339.8)	15900	(450.2)	17400	(492.7)	18600	(526.7)					
		40°	60	4.14	4300	(121.8)	10500	(297.3)	12500	(354.0)	20000	(566.6)	20000	(566.6)	20000	(566.6)					
		40°	70	4.83	5050	(143.0)	10600	(300.2)	13400	(379.4)	20000	(566.6)									
		40°	80	5.52	5700	(161.4)	10800	(305.8)	14400	(407.8)											
		40°	90	6.21	6300	(178.4)	11000	(311.5)	15820	(448)											
		40°	100	6.90	6800	(192.5)	16500	(467.2)	16520	(467.8)											
		40°	125	8.63	7600	(215.2)	19000	(538)	20000	(566.3)											

Inlet Effect A (in. w.c.)	0.1	0.3	0.4	0.6	0.7	1.2	2.0	2.4
Lock Up B (in. w.c.)	0.3	0.3	0.5	1.0	1.1	1.3	1.6	2.2

Notes:

A. Change in outlet pressure for 10 PSIG inlet pressure change.

B. Outlet pressure increase required for lockup.

\*Individual regulator performance may vary from data shown.

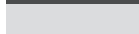
 Do not operate orifice in shaded inlet pressure area.  
 Inlet pressure is too low to deliver 7" w.c. (17.5 mbar).

# B38 PERFORMANCE CURVES

## 7" w.c. Set Point

Type and model	B38R
Inlet size	2" NPT
Outlet size	2" NPT
Orifice size	3/8"
Spring	Green

All test results are reported at a base of 14.7 PSIA and 60° F.

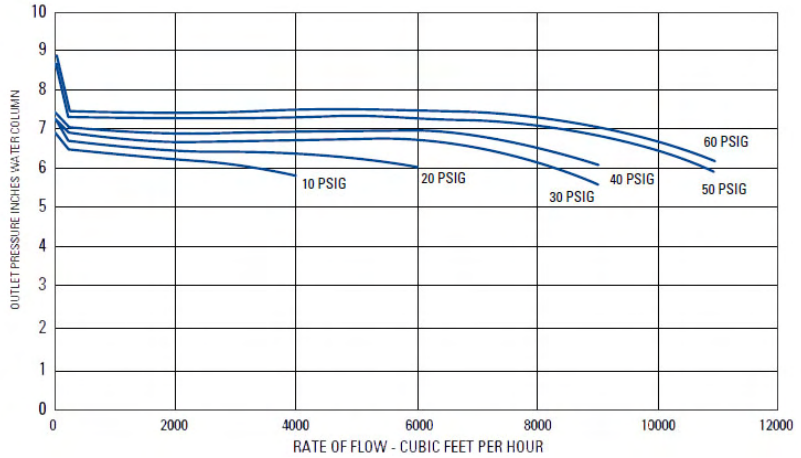

## RELIEF CURVES

### 7" w.c. Set Point

Inlet size	2" NPT
Outlet size	2" NPT
Vent size	2-1/2" NPT

All test results are reported at a base of 14.7 PSIG at 60° F and with 0.6 S.G. gas.

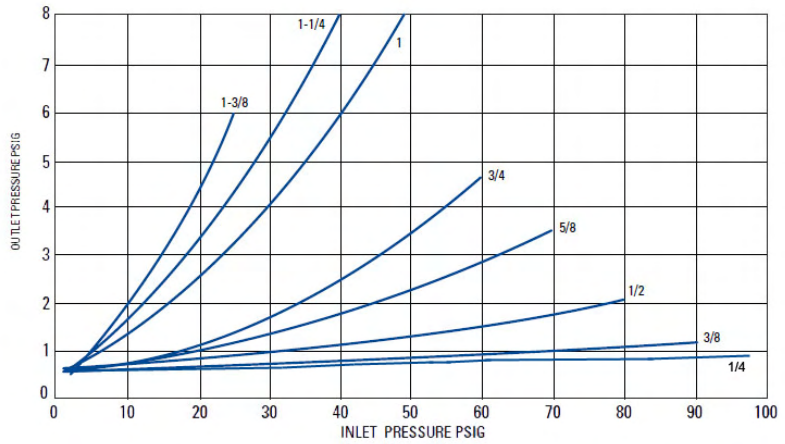

### 7" w.c. Set Point

Inlet size	2" NPT
Outlet size	2" NPT
Vent size	2" NPT

All test results are reported at a base of 14.7 PSIA at 60° F and with 0.6 S.G. gas.

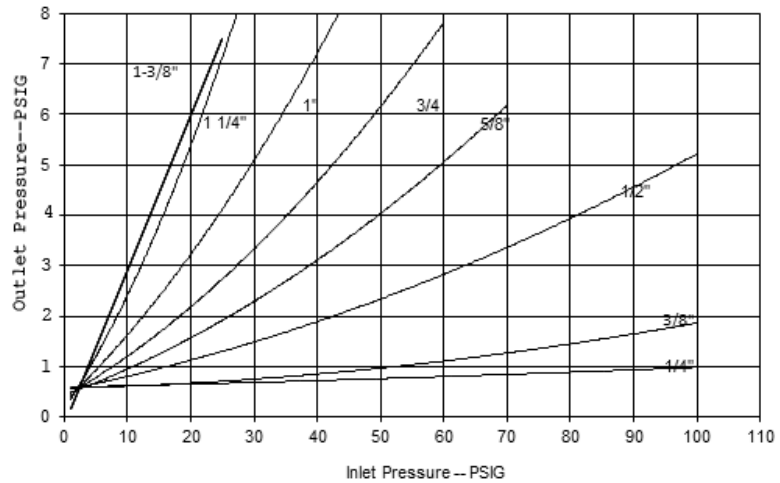

# B38 SERIES COMMERCIAL REGULATOR, MODELS N, R, M, AND D

14" w.c. (34 mbar) Capacity Table (2" Droop\*), 2" Inlet/Outlet

Capacities in SCFH (m<sup>3</sup>/hr) of 0.6 S.G. gas; base conditions of 14.7 PSIA and 60° F.

Typical Capacity Info.		Loading Ring Setting	Inlet Pressure		Orifice Size															
			PSIG	Bar	1/4"		3/8"		1/2"		5/8"		3/4"		1"		1-1/4"		1-3/8"	
<b>Manufacturer</b>	ROOTS Regulators	0°	21" w.c.	0.052	230	(6.4)	250	(7.0)	550	(15.4)	850	(23.8)	1250	(35.0)	1350	(37.8)	1900	(53.2)	2500	(70.0)
		40°			230	(6.4)	250	(7.0)	550	(15.4)	750	(21.0)	1050	(29.4)	1350	(37.8)	1700	(47.6)	2450	(68.6)
<b>Type and model</b>	B38R	0°	24" w.c.	0.060	270	(7.6)	280	(7.8)	625	(17.5)	950	(26.6)	1350	(37.8)	1700	(47.6)	2100	(58.8)	2450	(69.3)
<b>Inlet size</b>	2" NPT	40°			270	(7.6)	260	(7.3)	625	(17.5)	950	(26.6)	1150	(32.2)	1500	(42.0)	2040	(57.1)	2400	(67.2)
<b>Outlet size</b>	2" NPT	0°	1	0.069	320	(9.0)	325	(9.1)	750	(21.0)	1150	(32.2)	1650	(46.2)	2100	(58.8)	2150	(60.2)	2300	(64.4)
<b>Position</b>	11	40°			300	(8.4)	300	(8.4)	700	(19.8)	1175	(32.9)	1350	(37.8)	2000	(56.0)	2050	(58.0)	2250	(63.0)
<b>Loading ring setting</b>	0°	0°	2	0.14	570	(16.0)	1000	(28.0)	1400	(39.2)	2100	(58.8)	2500	(70.0)	3100	(86.8)	3500	(98.0)	5000	(140.0)
	40°	40°			550	(15.4)	850	(23.8)	1200	(33.6)	1900	(53.2)	2200	(61.6)	2700	(75.6)	3000	(84.0)	3200	(89.6)
	0°	0°	3	0.21	730	(20.4)	1200	(33.6)	1600	(44.8)	2400	(67.2)	3200	(89.6)	4700	(131.6)	6500	(182.0)	7000	(196.0)
	40°	40°			700	(19.6)	1000	(28.0)	1300	(36.4)	2100	(58.8)	2900	(81.2)	3300	(92.4)	5300	(148.4)	5500	(154.0)
	0°	0°	5	0.35	950	(26.6)	1700	(47.6)	2100	(58.8)	3500	(98.0)	5000	(140.0)	7000	(196.0)	8500	(238.0)	9000	(252.0)
	40°	40°			900	(25.2)	1500	(42.0)	1900	(53.2)	3000	(84.0)	3500	(98.0)	5300	(148.4)	5500	(154.0)	6500	(182.0)
	0°	0°	10	0.69	1500	(42.0)	3000	(84.0)	5000	(140.0)	6500	(184.0)	9000	(252.0)	10500	(294.0)	12500	(350.0)	13500	(378.0)
	40°	40°			1260	(35.3)	3000	(84.0)	4500	(126.0)	6300	(176.4)	7500	(210.0)	8200	(229.6)	8500	(240.6)	9000	(254.8)
	0°	0°	20	1.38	2180	(61.0)	4500	(126.0)	8000	(224.0)	10500	(294.0)	13500	(378.0)	15500	(434.0)	19000	(532.0)	20000	(566.0)
	40°	40°			2160	(60.5)	4500	(126.0)	7500	(210.0)	10000	(280.0)	11500	(322.0)	13450	(380.9)	17500	(495.5)	18000	(510.0)
	0°	0°	30	2.07	2850	(79.8)	6500	(182.0)	10500	(294.0)	14000	(392.0)	17500	(490.0)	20000	(566.0)	20000	(566.0)		
	40°	40°			2800	(78.4)	6500	(182.0)	9000	(252.0)	12000	(336.0)	13000	(368.0)	14500	(410.6)	18000	(510.0)		
	0°	0°	40	2.76	3500	(98.0)	7600	(212.8)	13000	(364.0)	18500	(518.0)	20000	(560.0)	20000	(560.0)	20000	(566.0)		
	40°	40°			3450	(96.6)	7600	(212.8)	10000	(280.0)	13000	(364.0)	14000	(396.4)	15500	(434.0)	18500	(523.9)		
	0°	0°	50	3.45	4100	(114.8)	9000	(252.0)	15000	(420.0)	20000	(566.0)	20000	(566.0)	20000	(566.0)				
	40°	40°			4100	(114.8)	9000	(252.0)	11500	(322.0)	13500	(378.0)	14500	(410.6)	15700	(444.6)				
	0°	0°	60	4.14	4730	(132.4)	10500	(294.0)	17500	(490.0)	20000	(566.0)	20000	(566.0)	20000	(566.0)				
	40°	40°			4730	(132.4)	10500	(294.0)	12200	(341.6)	14200	(397.0)	15000	(424.7)	16500	(467.2)				
	40°	40°	70	4.83	5450	(152.6)	11770	(329.6)	12840	(359.5)	14935	(418.2)								
	40°	40°	80	5.52	6215	(174.0)	12995	(363.9)	14125	(395.5)	16950	(474.6)								
	40°	40°	90	6.21	6490	(181.7)	14160	(396.5)	15340	(429.5)	17700	(495.6)								
	40°	40°	100	6.90	7190	(201.3)	15480	(438.0)	16920	(478.0)	18500	(523.0)								
	40°	40°	125	8.63	8940	(250.3)	13860	(392.0)	20600	(583.0)	20000	(566.0)								

Inlet Effect A (in. w.c.)	0.1	0.3	0.4	0.55	0.8	1.7	1.8	2.0
Lock Up B (in. w.c.)	0.2	0.7	1.4	1.9	2.0	2.6	2.9	3.1

**Notes:**

A. Change in outlet pressure for 10 PSIG inlet pressure change.

B. Outlet pressure increase required for lockup.

\*Individual regulator performance may vary from data shown.

 Do not operate orifice in shaded inlet pressure area.

# B38 SERIES COMMERCIAL REGULATOR, MODELS N, R, M, AND D

14" w.c. (34 mbar) Capacity Table (2" Droop\*), 1-1/2" Inlet/Outlet

Capacities in SCFH (m<sup>3</sup>/hr) of 0.6 S.G.gas; base conditions of 14.7 PSIA and 60° F.

Typical Capacity Info.		Loading Ring Setting	Inlet Pressure		Orifice Size															
			PSIG	Bar	1/4"		3/8"		1/2"		5/8"		3/4"		1"		1-1/4"		1-3/8"	
<b>Manufacturer</b>	ROOTS Regulators	0°	21" w.c.	0.052	230	(6.4)	250	(7.0)	550	(15.4)	805	(22.9)	1185	(33.6)	1285	(36.3)	1805	(51.1)	2375	(67.3)
					40°	230	(6.4)	250	(7.0)	550	(15.4)	715	(20.2)	1000	(28.2)	1285	(36.3)	1615	(45.7)	2325
<b>Type and model</b>	B38R	0°	24" w.c.	0.060	240	(6.8)	270	(7.6)	600	(17.0)	900	(25.5)	1280	(36.3)	1615	(45.7)	1995	(56.5)	2400	(65.9)
<b>Inlet size</b>	1-1/2" NPT				40°	240	(6.8)	255	(7.2)	600	(17.0)	900	(25.5)	1090	(30.9)	1425	(40.3)	1720	(48.7)	2400
<b>Outlet size</b>	1-1/2" NPT	0°	1	0.069	310	(8.8)	320	(9.0)	700	(19.8)	1090	(30.9)	1565	(44.4)	1995	(56.5)	2040	(57.8)	3110	(88.0)
<b>Position</b>	11				40°	290	(8.2)	300	(8.4)	675	(19.1)	1115	(31.6)	1280	(36.3)	1900	(53.8)	1950	(53.8)	2700
<b>Loading ring setting</b>	0°	0°	2	0.14	490	(13.9)	900	(25.5)	1325	(37.5)	1995	(56.5)	2375	(67.3)	2945	(83.4)	3325	(94.2)	4750	(134.5)
	40°				480	(13.6)	825	(23.4)	1130	(32)	1805	(51.1)	2090	(59.2)	2565	(72.6)	2850	(80.7)	3040	(86.1)
	0°	0°	3	0.21	690	(19.5)	1140	(32.3)	1600	(44.8)	2280	(64.6)	3040	(86.1)	4465	(126.4)	6175	(174.9)	5560	(188.3)
	40°				610	(17.3)	920	(26)	1225	(34.7)	1995	(56.5)	2755	(78.0)	3135	(88.8)	5035	(142.6)	5225	(148.0)
	0°	0°	5	0.35	890	(25.2)	1580	(44.7)	1980	(56)	3325	(94.2)	4750	(134.5)	6650	(188.3)	8075	(228.7)	8550	(242.1)
	40°				785	(22.2)	1130	(32)	1730	(49)	2850	(80.7)	3325	(94.2)	5035	(142.6)	5225	(148.0)	6175	(174.9)
	0°	0°	10	0.69	1360	(42.0)	2820	(80.0)	3600	(102.0)	3825	(108.3)	8550	(242.1)	9975	(282.5)	11875	(336.3)	12825	(363.2)
	40°				1150	(32.6)	2710	(76.7)	3520	(99.6)	5985	(169.5)	7125	(201.8)	7790	(220.6)	9025	(255.6)	10100	(286.0)
	0°	0°	20	1.38	2060	(58.3)	4350	(123.0)	7540	(213.5)	9975	(282.5)	12825	(363.2)	14725	(417.0)	18050	(511.1)	19000	(538.0)
	40°				1980	(56.0)	3100	(87.7)	6680	(189.0)	9500	(269.0)	9500	(269.0)	10450	(295.9)	10450	(309.7)	11200	(317.1)
	0°	0°	30	2.07	2710	(76.7)	6380	(180.6)	9860	(279.0)	13300	(376.6)	16625	(470.8)	19000	(538.0)	20000	(566.0)		
	40°				2640	(74.7)	6100	(172.7)	9250	(262.0)	11400	(322.8)	10925	(309.4)	10925	(309.4)	7600	(215.2)		
	0°	0°	40	2.76	3300	(93.4)	7450	(210.9)	12500	(354.0)	17575	(497.7)	20000	(566.0)	20000	(566.0)	20000	(566.0)		
	40°				3200	(90.6)	7100	(201.0)	9770	(276.6)	12350	(349.7)	11400	(322.8)	10925	(309.4)	8075	(228.7)		
	0°	0°	50	3.45	3960	(112.0)	8500	(240.7)	14200	(402.0)	20000	(566.0)	20000	(566.0)	20000	(566.0)				
	40°				3740	(106.0)	8000	(226.5)	10900	(308.6)	12825	(363.2)	11875	(295.9)	10450	(295.9)				
	0°	0°	60	4.14	4730	(132.4)	10500	(282.5)	17500	(490.0)	20000	(566.0)	20000	(566.0)	20000	(566.0)				
	40°				4495	(127.2)	9755	(316.6)	11590	(328.2)	13490	(382.0)	11875	(336.3)	10450	(295.9)				
	40°	70	4.83	5175	(146.6)	11180	(316.6)	12195	(345.4)	14190	(401.8)									
	40°	80	5.52	5905	(167.2)	12345	(349.6)	13420	(380.0)											
	40°	90	6.21	6165	(174.6)	13450	(380.9)	14575	(412.7)											
	40°	100	6.90	6830	(193.4)	1470	(416.4)	16075	(455.2)											
	40°	125	8.63	8495	(240.5)	15165	(372.9)	19570	(554.2)											

Inlet Effect A (in. w.c.)	0.1	0.3	0.4	0.55	0.8	1.7	1.8	2.0
Lock Up B (in. w.c.)	0.2	0.7	1.4	1.9	2.0	2.6	2.9	3.1

Notes:

A. Change in outlet pressure for 10 PSIG inlet pressure change.

B. Outlet pressure increase required for lockup.

\*Individual regulator performance may vary from data shown.

 Do not operate orifice in shaded inlet pressure area.

# B38 PERFORMANCE CURVES

## 14" w.c. Set Point

<b>Type and model</b>	B38R
Inlet size	2" NPT
Outlet size	2" NPT
Orifice size	3/8"
Spring	Purple

All test results are reported at a base of 14.7 PSIA at 60° F and with 0.6 S.G. gas.

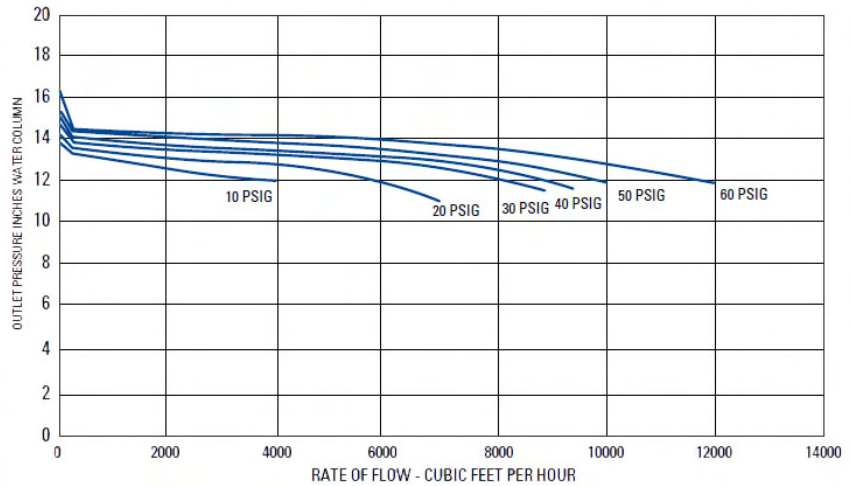

## RELIEF CURVES

### 14" w.c. Set Point

Inlet size	2" NPT
Outlet size	2" NPT
Vent size	2-1/2" NPT

All test results are reported at a base of 14.7 PSIG at 60° F and with 0.6 S.G. gas.

Set point 14.0" w.c. with 40 PSIG inlet @ 200 SCFH.

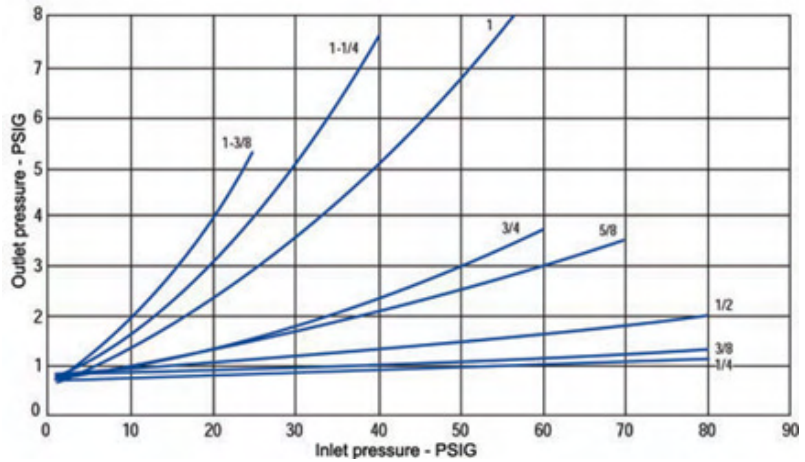

### 14" w.c. Set Point

Inlet size	2" NPT
Outlet size	2" NPT
Vent size	2" NPT

All test results are reported at a base of 14.7 PSIA at 60° F and with 0.6 S.G. gas.

B-38R Relief Curves – Blocked Per Orifice  
14" w.c. Set Point

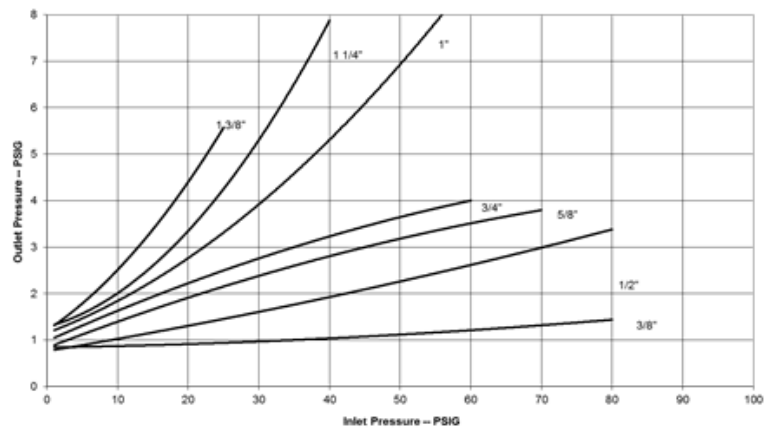

# B38 SERIES COMMERCIAL REGULATOR, MODELS N, R, M, AND D

1 PSIG (69 mbar) Capacity Table (1% Absolute Droop\*), 2" Inlet/Outlet

Capacities in SCFH (m<sup>3</sup>/hr) of 0.6 S.G.gas; base conditions of 14.7 PSIA and 60° F.

Typical Capacity Info.		Inlet Pressure		Orifice Size															
		PSIG	Bar	1/4"	3/8"	1/2"	5/8"	3/4"	1"	1-1/4"	1-3/8"								
<b>Manufacturer</b>	ROOTS Regulators	2	(0.14)	480	(13.4)	800	(22.4)	1300	(36.4)	1650	(46.2)	2300	(64.4)	2700	(75.6)	3300	(92.4)	4200	(117.6)
		3	(0.21)	620	(17.4)	1150	(32.2)	1700	(47.6)	2200	(61.6)	3300	(92.4)	4000	(112.0)	4350	(121.8)	5000	(140.0)
<b>Type and model</b>	B38R	5	(0.35)	880	(24.6)	1700	(47.6)	2400	(67.2)	3150	(88.2)	4500	(126.0)	5200	(145.6)	6500	(182.0)	7500	(210.0)
Inlet size	2" NPT	10	(0.69)	1250	(35.0)	2500	(70.0)	4000	(112.0)	6000	(168.0)	6500	(182.0)	8500	(238.0)	11000	(308.0)	11200	(313.6)
Outlet size	2" NPT	20	(1.38)	2100	(58.8)	4300	(120.4)	7000	(196.0)	9000	(252.0)	11000	(308.0)	14000	(392.0)	17000	(476.0)	20000	(566.0)
Spring color	Silver	30	(2.07)	2800	(78.4)	6200	(173.6)	9400	(263.2)	12500	(350.0)	14500	(406.0)	18500	(518.0)	20000	(566.0)	20000	(566.0)
<b>Position</b>	11	40	(2.76)	3500	(98.0)	7500	(210.0)	12000	(336.0)	15000	(420.0)	19000	(532.0)	20000	(566.0)	20000	(566.0)	20000	(566.0)
<b>Loading ring setting</b>	0°	50	(3.45)	4150	(116.2)	8500	(238.0)	14000	(392.0)	20000	(566.0)	20000	(566.0)	20000	(566.0)	20000	(566.0)	20000	(566.0)
		60	(4.14)	4670	(130.8)	10500	(294.0)	15500	(434.0)	20000	(566.0)	20000	(566.0)	20000	(566.0)	20000	(566.0)		
		70	(4.83)	5450	(152.6)	11330	(317.2)	19795	(554.3)	20000	(566.0)	20000	(566.0)	20000	(566.0)	20000	(566.0)		
		80	(5.52)	5990	(167.7)	12995	(363.9)	20000	(566.0)	20000	(566.0)	20000	(566.0)	20000	(566.0)				
		90	(6.21)	6550	(183.4)	14160	(396.5)	20000	(566.0)	20000	(566.0)	20000	(566.0)	20000	(566.0)				
		100	(6.90)	7790	(218.1)	15200	(430.0)	20000	(566.0)	20000	(566.0)	20000	(566.0)	20000	(566.0)				
		125	(8.63)	8790	(246.1)	17100	(483.0)	20000	(566.0)	20000	(566.0)	20000	(566.0)						

Inlet Effect A (PSIG)	0.01	0.01	0.04	0.02	0.03	0.06	0.08	0.11
Lock Up B (PSIG)	0.02	0.06	0.05	0.06	0.07	0.11	0.13	0.15

Notes:

A. Change in outlet pressure for 10 PSIG inlet pressure change.

B. Outlet pressure increase required for lockup.

\*Individual regulator performance may vary from data shown.

 Do not operate orifice in shaded inlet pressure area.

# B38 SERIES COMMERCIAL REGULATOR, MODELS N, R, M, AND D

## 1 PSIG (69 mbar) Capacity Table (2% Absolute Droop\*), 2" Inlet/Outlet

Capacities in SCFH of 0.6 S.G. (m<sup>3</sup>/hr) gas; base conditions of 14.7 PSIA and 60° F.

### Typical Capacity Info.

<b>Manufacturer</b>	ROOTS Regulators
<b>Type and model</b>	B38
<b>Inlet size</b>	2" NPT
<b>Outlet size</b>	2" NPT
<b>Position</b>	11
<b>Loading ring setting</b>	0°

Inlet Pressure		Orifice Size																	
		PSIG		1/4"		3/8"		1/2"		5/8"		3/4"		1"		1-1/4"		1- 3/8"	
2	(0.14)	530	(14.8)	1070	(30.0)	1400	(39.2)	2100	(58.8)	3200	(89.6)	4300	(120.4)	5000	(140.0)	6200	(173.6)		
3	(0.21)	730	(20.4)	1450	(40.6)	2200	(61.6)	3050	(85.4)	4000	(112.0)	5250	(147.0)	6400	(179.2)	7500	(210.0)		
5	(0.35)	1010	(28.3)	2200	(61.6)	3200	(89.6)	4400	(123.2)	6300	(176.4)	8000	(224.0)	10000	(280.0)	10500	(294.0)		
10	(0.69)	1520	(42.6)	3100	(86.8)	4200	(117.6)	7500	(210.0)	9000	(252.0)	11500	(322.0)	14100	(399.0)	14500	(406.0)		
20	(1.38)	2150	(60.2)	4700	(131.6)	8000	(224.0)	11500	(322.0)	14000	(392.0)	18000	(504.0)	20000	(566.0)	20000	(566.0)		
30	(2.07)	2820	(79.0)	6400	(179.2)	10500	(294.0)	15000	(420.0)	18500	(518.0)	20000	(566.0)	20000	(566.0)	20000	(566.0)		
40	(2.76)	3500	(98.0)	7500	(210.0)	13000	(364.0)	18500	(518.0)	20000	(566.0)	20000	(566.0)	20000	(566.0)	20000	(566.0)		
50	(3.45)	4150	(116.2)	8800	(246.4)	15500	(434.0)	20000	(566.0)	20000	(566.0)	20000	(566.0)	20000	(566.0)	20000	(566.0)		
60	(4.14)	4670	(130.8)	10500	(294.0)	17500	(490.0)	20000	(566.0)	20000	(566.0)	20000	(566.0)	20000	(566.0)	20000	(566.0)		
70	(4.83)	5450	(152.6)	11330	(317.2)	18500	(518.0)	20000	(566.0)	20000	(566.0)	20000	(566.0)	20000	(566.0)	20000	(566.0)		
80	(5.52)	5990	(167.7)	12995	(363.9)	20000	(566.0)	20000	(566.0)	20000	(566.0)	20000	(566.0)	20000	(566.0)	20000	(566.0)		
90	(6.21)	6550	(183.4)	14160	(396.5)	20000	(566.0)	20000	(566.0)	20000	(566.0)	20000	(566.0)	20000	(566.0)	20000	(566.0)		
100	(6.90)	7190	(201.3)	15200	(430.0)	20000	(566.0)	20000	(566.0)	20000	(566.0)	20000	(566.0)	20000	(566.0)	20000	(566.0)		
125	(8.63)	8790	(246.1)	17100	(483.0)	20000	(566.0)	20000	(566.0)	20000	(566.0)	20000	(566.0)	20000	(566.0)	20000	(566.0)		

Inlet Effect A (PSIG)	0.01	0.01	0.04	0.02	0.03	0.06	0.08	0.11
Lock Up B (PSIG)	0.02	0.06	0.05	0.06	0.07	0.11	0.13	0.15

Notes:

A. Change in outlet pressure for 10 PSIG inlet pressure change.

B. Outlet pressure increase required for lockup.

\*Individual regulator performance may vary from data shown.

 Do not operate orifice in shaded inlet pressure area.



# B38 SERIES COMMERCIAL REGULATOR, MODELS N, R, M, AND D

## 1 PSIG (69 mbar) Capacity Table (1% Absolute Droop\*), 1-1/2" NPT Inlet/Outlet

Capacities in SCFH (m<sup>3</sup>/hr) of 0.6 S.G.gas; base conditions of 14.7 PSIA and 60° F.

Typical Capacity Info.	
<b>Manufacturer</b>	ROOTS Regulators
<b>Type and model</b>	B38R
<b>Inlet size</b>	1-1/2" NPT
<b>Outlet size</b>	1-1/2" NPT
<b>Position</b>	11
<b>Loading ring setting</b>	0°

Inlet Pressure		Orifice Size															
		1/4"		3/8"		1/2"		5/8"		3/4"		1"		1-1/4"		1- 3/8"	
PSIG	Bar	1/4"		3/8"		1/2"		5/8"		3/4"		1"		1-1/4"		1- 3/8"	
2	(0.14)	456	(12.9)	760	(21.5)	1235	(35.0)	1567	(44.4)	2185	(64.9)	2565	(72.6)	3135	(88.8)	3990	(113.0)
3	(0.21)	589	(16.7)	1092	(30.9)	1615	(45.7)	2090	(59.2)	3135	(88.9)	3800	(107.6)	4132	(117.0)	4750	(134.5)
5	(0.35)	836	(23.7)	1615	(45.7)	2280	(64.6)	2992	(84.7)	4275	(121.1)	4940	(140.0)	6175	(174.9)	7125	(201.8)
10	(0.69)	1187	(33.6)	2375	(67.3)	3800	(107.6)	5700	(161.4)	6175	(174.9)	8075	(228.7)	10450	(295.9)	10640	(301.3)
20	(1.38)	1995	(56.5)	4085	(115.7)	6650	(188.3)	8550	(242.1)	10450	(295.9)	13300	(376.6)	16150	(457.3)	19000	(538.0)
30	(2.07)	2660	(75.3)	5890	(166.8)	8930	(252.9)	11875	(336.3)	13775	(390.1)	17575	(497.7)	20000	(566.0)	20000	(566.0)
40	(2.76)	3325	(94.2)	7125	(201.8)	11400	(322.8)	14250	(403.5)	18050	(511.1)	20000	(566.0)	20000	(566.0)	20000	(566.0)
50	(3.45)	3942	(111.6)	8075	(228.7)	13300	(376.6)	20000	(566.0)	20000	(566.0)	20000	(566.0)	20000	(566.0)	20000	(566.0)
60	(4.14)	4436	(125.6)	9975	(282.5)	14725	(417.0)	20000	(566.0)	20000	(566.0)	20000	(566.0)	20000	(566.0)		
70	(4.83)	5177	(146.6)	10763	(304.8)	18805	(532.5)	20000	(566.0)	20000	(566.0)	20000	(566.0)	20000	(566.0)		
80	(5.52)	5690	(161.1)	12345	(349.6)	19000	(538.0)	20000	(566.0)	20000	(566.0)	20000	(566.0)				
90	(6.21)	6222	(176.2)	13452	(380.9)	20000	(566.0)	20000	(566.0)	20000	(566.0)	20000	(566.0)				
100	(6.90)	7400	(209.5)	14440	(408.9)	20000	(566.0)	20000	(566.0)	20000	(566.0)	20000	(566.0)				
125	(8.63)	8350	(236.5)	16245	(460.0)	20000	(566.0)	20000	(566.0)	20000	(566.0)						

Inlet Effect A (PSIG)	0.01	0.01	0.04	0.02	0.03	0.06	0.08	0.11
Lock Up B (PSIG)	0.02	0.06	0.05	0.06	0.07	0.11	0.13	0.15

Notes:

A. Change in outlet pressure for 10 PSIG inlet pressure change.

B. Outlet pressure increase required for lockup.

\*Individual regulator performance may vary from data shown.

 Do not operate orifice in shaded inlet pressure area.

# B38 SERIES COMMERCIAL REGULATOR, MODELS N, R, M, AND D

## 1 PSIG (69 mbar) Capacity Table (2% Absolute Droop\*), 1-1/2" Inlet/Outlet

Capacities in SCFH of 0.6 S.G. (m<sup>3</sup>/h) gas; base conditions of 14.7 PSIA and 60° F.

Typical Capacity Info.	
<b>Manufacturer</b>	ROOTS Regulators
<b>Type and model</b>	B38
Inlet size	1-1/2" NPT
Outlet size	1-1/2" NPT
<b>Position</b>	11
<b>Loading ring setting</b>	0°

Inlet Pressure		Orifice Size															
		PSIG	Bar	1/4"	3/8"	1/2"	5/8"	3/4"	1"	1-1/4"	1- 3/8"						
2	(0.14)	503	(14.2)	1016	(28.8)	1330	(37.7)	1995	(56.5)	3040	(86.1)	4085	(115.7)	4750	(134.5)	5890	(166.8)
3	(0.21)	693	(19.6)	1377	(39.0)	2090	(59.2)	3289	(82.0)	3800	(107.6)	4987	(141.2)	6080	(172.2)	7125	(201.8)
5	(0.35)	959	(27.2)	2090	(59.2)	3040	(86.1)	4180	(118.4)	5985	(169.5)	7600	(215.2)	9500	(269.0)	9975	(282.5)
10	(0.69)	1444	(40.9)	2945	(83.4)	3990	(113.0)	7125	(201.8)	8550	(242.1)	10925	(309.4)	12965	(367.0)	13775	(390.1)
20	(1.38)	2042	(57.8)	4465	(126.4)	7600	(215.2)	10925	(309.4)	13300	(376.6)	17100	(484.2)	18800	(532.0)	19100	(548.0)
30	(2.07)	2679	(75.9)	6080	(172.2)	9975	(282.5)	15000	(420.0)	18500	(518.0)	19000	(538.0)	19300	(546.5)	19800	(560.6)
40	(2.76)	3325	(94.2)	7125	(201.8)	12350	(349.7)	18500	(518.0)	19700	(557.8)	20000	(566.0)	20000	(566.0)	20000	(566.0)
50	(3.45)	3942	(111.6)	8360	(236.7)	14725	(417.0)	19900	(538.0)	20000	(566.0)	20000	(566.0)	20000	(566.0)	20000	(566.0)
60	(4.14)	4436	(125.6)	9975	(282.5)	16625	(470.8)	20000	(566.0)	20000	(566.0)	20000	(566.0)	20000	(566.0)		
70	(4.83)	5177	(146.6)	10763	(304.8)	17575	(497.7)	20000	(566.0)	20000	(566.0)	20000	(566.0)				
80	(5.52)	5690	(161.7)	12345	(349.6)	19000	(538.0)	20000	(566.0)	20000	(566.0)	20000	(566.0)				
90	(6.21)	6222	(176.2)	13452	(380.9)	20000	(566.0)	20000	(566.0)	20000	(566.0)	20000	(566.0)				
100	(6.90)	6830	(193.4)	14440	(408.9)	20000	(566.0)	20000	(566.0)	20000	(566.0)	20000	(566.0)				
125	(8.63)	8350	(236.4)	16245	(460.0)	20000	(566.0)	20000	(566.0)	20000	(566.0)						

Inlet Effect A (PSIG)	0.01	0.01	0.04	0.02	0.03	0.06	0.08	0.11
Lock Up B (PSIG)	0.02	0.06	0.05	0.06	0.07	0.11	0.13	0.15

Notes:

A. Change in outlet pressure for 10 PSIG inlet pressure change.

B. Outlet pressure increase required for lockup.

\*Individual regulator performance may vary from data shown.



Do not operate orifice in shaded inlet pressure area.

# B38 PERFORMANCE CURVES

## 1 PSIG Set Point

<b>Type and model</b>	B38R
Inlet size	2" NPT
Outlet size	2" NPT
Orifice size	3/8"
Spring	Blue/white

All test results are reported at a base of 14.7 PSIA at 60° F and with 0.6 S.G. gas.

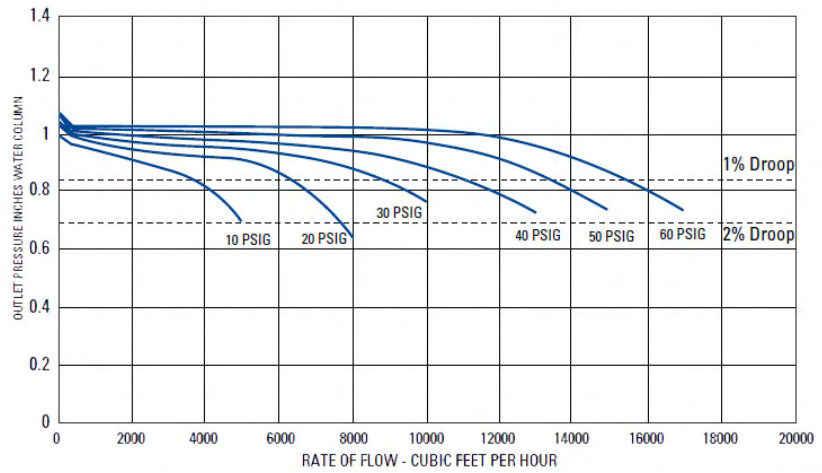

## RELIEF CURVES

### 1 PSIG Set Point

Inlet size	2" NPT
Outlet size	2" NPT
Vent size	2-1/2" NPT

All test results are reported at a base of 14.7 PSIA at 60° F and with 0.6 S.G. gas.

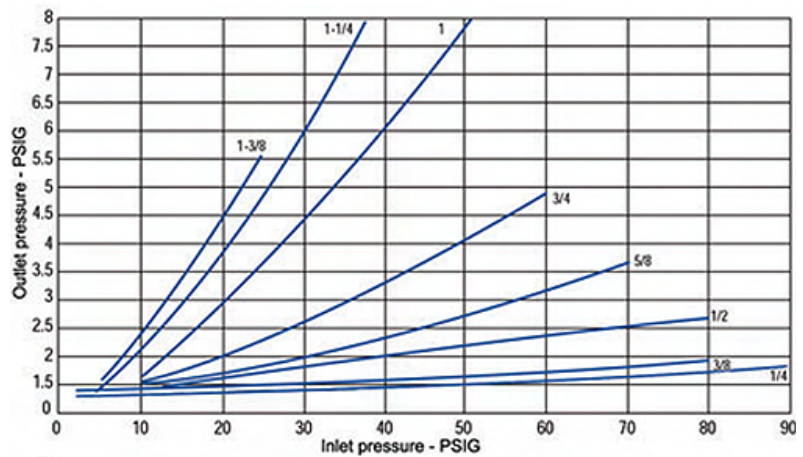

### 1 PSIG Set Point

Inlet size	2" NPT
Outlet size	2" NPT
Vent size	2" NPT

All test results are reported at a base of 14.7 PSIA at 60° F and with 0.6 S.G. gas.

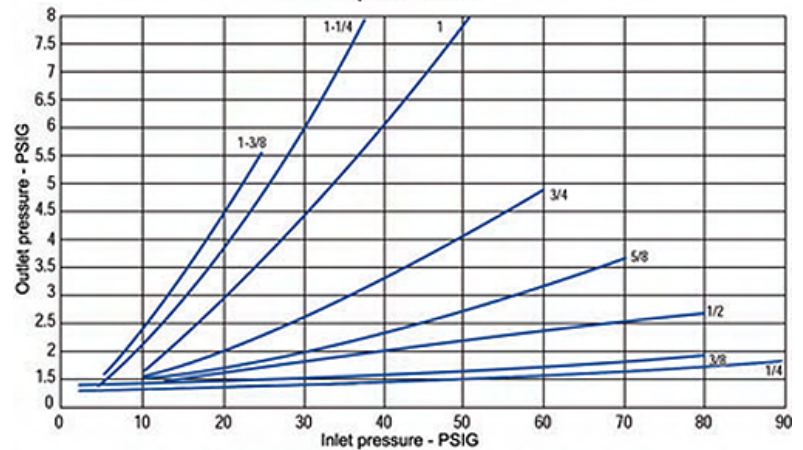

# B38 SERIES COMMERCIAL REGULATOR, MODELS N, R, M, AND D

## 2 PSIG (138 mbar) Capacity Table (1% Absolute Droop\*), 2" NPT Inlet/Outlet

3/hr) of 0.6 S.G. gas; base conditions of 14.7 PSIA and 60° F.

Typical Capacity Info.	
Manufacturer	ROOTS Regulators
Type and model	B38R
Inlet size	2" NPT
Outlet size	2" NPT
Position	11
Loading ring setting	0°

Inlet Pressure		Orifice Size															
		1/4"		3/8"		1/2"		5/8"		3/4"		1"		1-1/4"		1- 3/8"	
PSIG	Bar	340	(9.5)	850	(23.8)	700	(19.6)	800	(22.4)	1200	(33.6)	1600	(44.8)	1750	(49.0)	2050	(57.4)
3	(0.21)	540	(15.1)	1350	(37.8)	1200	(33.6)	1450	(40.6)	1650	(46.2)	2300	(64.4)	2850	(79.8)	3100	(86.8)
5	(0.35)	940	(26.3)	1500	(42.0)	1900	(53.2)	2500	(70.0)	3100	(86.8)	4800	(134.4)	5800	(162.4)	6300	(176.4)
10	(0.69)	1850	(51.8)	2700	(75.6)	3000	(84.0)	3700	(103.6)	7200	(201.6)	9000	(252.0)	10500	(249.0)	11500	(322.0)
20	(1.38)	2250	(63.0)	3800	(106.4)	4700	(131.6)	7500	(210.0)	10200	(285.6)	12500	(350.0)	16000	(448.0)	20000	(566.0)
30	(2.07)	3100	(86.8)	5300	(148.4)	8000	(224.0)	9800	(274.4)	13500	(378.0)	17500	(490.0)	20000	(566.0)	20000	(566.0)
40	(2.76)	3600	(100.8)	7000	(196.0)	10000	(280.0)	13000	(364.0)	14500	(406.0)	20000	(566.0)	20000	(566.0)	20000	(566.0)
50	(3.45)	4500	(126.0)	9000	(252.0)	14500	(406.0)	16300	(456.4)	20000	(566.0)	20000	(566.0)	20000	(566.0)		
60	(4.14)	5080	(142.2)	10300	(288.4)	13390	(374.9)	20000	(566.0)	20000	(566.0)	20000	(566.0)	20000	(566.0)		
70	(4.83)	5990	(167.7)	11865	(332.2)	15594	(436.6)	20000	(566.0)	20000	(566.0)	20000	(566.0)				
80	(5.52)	6490	(181.7)	13216	(370.1)	16756	(469.2)	20000	(566.0)	20000	(566.0)	20000	(566.0)				
90	(6.21)	7190	(201.3)	16500	(462.0)	20000	(566.0)	20000	(566.0)	20000	(566.0)	20000	(566.0)				
100	(6.90)	8940	(250.3)	19600	(548.8)	20000	(566.0)	20000	(566.0)	20000	(566.0)						
125	(8.63)																

Inlet Effect A (PSIG)	0.01	0.01	0.04	0.02	0.03	0.06	0.08	0.11
Lock Up B (PSIG)	0.02	0.06	0.05	0.06	0.07	0.11	0.13	0.15

Notes:

A. Change in outlet pressure for 10 PSIG inlet pressure change.

B. Outlet pressure increase required for lockup.

\*Individual regulator performance may vary from data shown.

 Do not operate orifice in shaded inlet pressure area.

# B38 SERIES COMMERCIAL REGULATOR, MODELS N, R, M, AND D

## 2 PSIG (138 mbar) Capacity Table (2% Absolute Droop\*), 2" NPT Inlet/Outlet

Capacities in SCFH (m<sup>3</sup>/hr) of 0.6 S.G. gas; base conditions of 14.7 PSIA and 60° F.

Typical Capacity Info.	
<b>Manufacturer</b>	ROOTS Regulators
<b>Type and model</b>	B38R
<b>Inlet size</b>	2" NPT
<b>Outlet size</b>	2" NPT
<b>Position</b>	11
<b>Loading ring setting</b>	0°

Inlet Pressure		Orifice Size															
		PSIG	Bar	1/4"	3/8"	1/2"	5/8"	3/4"	1"	1-1/4"	1- 3/8"						
3	(0.21)	510	(14.8)	1200	(33.6)	1200	(33.6)	1550	(43.4)	2000	(56.0)	3250	(91.0)	3400	(95.2)	3975	(111.3)
		850	(23.8)	1650	(46.2)	2050	(57.4)	2500	(70.0)	3300	(92.4)	4450	(124.6)	5800	(162.4)	6350	(177.8)
10	(0.69)	1400	(39.2)	2400	(67.2)	3700	(103.6)	4800	(134.4)	6100	(170.8)	8000	(224.0)	10200	(285.6)	11500	(322.0)
20	(1.38)	2100	(61.6)	4200	(117.6)	5100	(142.8)	8000	(224.0)	11000	(308.0)	13000	(364.0)	15500	(434.0)	18500	(518.0)
30	(2.07)	2790	(78.7)	5700	(159.6)	8500	(238.0)	10500	(294.0)	14200	(397.6)	17500	(490.0)	20000	(566.0)	20000	(566.0)
40	(2.76)	3400	(98.0)	7000	(196.0)	10500	(294.0)	13500	(378.0)	18500	(518.0)	20000	(566.0)	20000	(566.0)	20000	(566.0)
50	(3.45)	4040	(114.8)	8800	(246.4)	12500	(350.0)	16000	(448.0)	20000	(566.0)	20000	(566.0)	20000	(566.0)	20000	(566.0)
60	(4.14)	4660	(134.4)	9700	(271.6)	16500	(462.0)	20000	(566.0)	20000	(566.0)	20000	(566.0)	20000	(566.0)		
70	(4.83)	5290	(151.2)	11330	(317.2)	15965	(447.0)	20000	(566.0)	20000	(566.0)	20000	(566.0)	20000	(566.0)		
80	(5.52)	5990	(167.7)	13108	(367.0)	19210	(537.9)	20000	(566.0)	20000	(566.0)	20000	(566.0)				
90	(6.21)	6540	(184.8)	14160	(396.5)	20000	(566.0)	20000	(566.0)	20000	(566.0)	20000	(566.0)				
100	(6.90)	7160	(201.3)	17000	(476.0)	20000	(566.0)	20000	(566.0)	20000	(566.0)	20000	(566.0)				
125	(8.63)	8731	(242.6)	20000	(566.0)	20000	(566.0)	20000	(566.0)	20000	(566.0)						

Inlet Effect A (PSIG)	0.04	0.01	0.04	0.06	0.03	0.07	0.12	0.13
Lock Up B (PSIG)	0.01	0.05	0.05	0.06	0.06	0.08	0.09	0.11

Notes:

A. Change in outlet pressure for 10 PSIG inlet pressure change.

B. Outlet pressure increase required for lockup.

\*Individual regulator performance may vary from data shown.



Do not operate orifice in shaded inlet pressure area.

# B38 SERIES COMMERCIAL REGULATOR, MODELS N, R, M, AND D

2 PSIG (138 mbar) Capacity Table (1% Absolute Droop\*), 1-1/2" NPT Inlet/Outlet

3/hr) of 0.6 S.G. gas; base conditions of 14.7 PSIA and 60° F.

Typical Capacity Info.	
<b>Manufacturer</b>	ROOTS Regulators
<b>Type and model</b>	B38R
<b>Inlet size</b>	1-1/2" NPT
<b>Outlet size</b>	1-1/2" NPT
<b>Position</b>	11
<b>Loading ring setting</b>	0°

Inlet Pressure		Orifice Size															
		PSIG	Bar	1/4"	3/8"	1/2"	5/8"	3/4"	1"	1-1/4"	1- 3/8"						
3	(0.21)	323	(9.1)	807	(22.9)	665	(18.8)	760	(21.5)	1140	(32.3)	1520	(43.0)	1662	(47.1)	1947	(54.1)
5	(0.35)	513	(14.5)	1140	(32.3)	1282	(36.3)	1377	(39.0)	1567	(44.4)	2185	(61.9)	2707	(76.7)	2945	(83.4)
10	(0.69)	893	(25.3)	1425	(40.4)	1805	(51.1)	2375	(67.3)	2945	(83.4)	4560	(129.1)	5510	(156.0)	5985	(169.5)
20	(1.38)	1757	(49.8)	2565	(72.6)	2850	(80.7)	3515	(99.5)	6840	(193.7)	8550	(242.1)	9975	(282.5)	10925	(309.4)
30	(2.07)	2137	(60.5)	3610	(102.2)	4465	(126.4)	7125	(201.8)	9690	(274.4)	11875	(336.3)	15200	(430.4)	17500	(495.5)
40	(2.76)	2945	(83.4)	5035	(142.6)	7600	(215.2)	9310	(263.6)	12825	(363.2)	16625	(470.8)	18100	(512.5)	19000	(538.0)
50	(3.45)	3420	(96.8)	6650	(188.3)	9500	(269.0)	12350	(349.7)	13775	(390.1)	18300	(518.0)	19000	(538.0)	20000	(566.0)
60	(4.14)	4275	(121.1)	8550	(242.1)	13775	(390.1)	15485	(438.5)	18400	(521.0)	19000	(538.0)	20000	(566.0)		
70	(4.83)	4826	(136.7)	9785	(277.1)	12721	(360.2)	17900	(506.8)	19000	(538.0)	20000	(566.0)	20000	(566.0)		
80	(5.52)	5690	(161.1)	11272	(319.2)	14814	(419.5)	19000	(538.0)	20000	(566.0)	20000	(566.0)				
90	(6.21)	6165	(174.6)	12555	(355.5)	15918	(450.1)	20000	(566.0)	20000	(566.0)	20000	(566.0)				
100	(6.90)	6830	(193.4)	15675	(443.9)	19000	(538.0)	20000	(566.0)	20000	(566.0)	20000	(566.0)				
125	(8.63)	8493	(240.5)	18620	(527.3)	20000	(566.0)	20000	(566.0)	20000	(566.0)						

Inlet Effect A (PSIG)	0.01	0.01	0.04	0.02	0.03	0.06	0.08	0.11
Lock Up B (PSIG)	0.02	0.06	0.05	0.06	0.07	0.11	0.13	0.15

Notes:

A. Change in outlet pressure for 10 PSIG inlet pressure change.

B. Outlet pressure increase required for lockup.

\*Individual regulator performance may vary from data shown.

 Do not operate orifice in shaded inlet pressure area.

# B38 SERIES COMMERCIAL REGULATOR, MODELS N, R, M, AND D

## 2 PSIG (138 mbar) Capacity Table (2% Absolute Droop\*), 1-1/2" NPT Inlet/Outlet

Capacities in SCFH (m<sup>3</sup>/hr) of 0.6 S.G. gas; base conditions of 14.7 PSIA and 60° F.

Typical Capacity Info.		Inlet Pressure		Orifice Size															
		PSIG	Bar	1/4"		3/8"		1/2"		5/8"		3/4"		1"		1-1/4"		1- 3/8"	
<b>Manufacturer</b>	ROOTS Regulators	3	(0.21)	505	(14.3)	1140	(32.2)	1150	(32.5)	1375	(38.9)	1900	(53.8)	3090	(87.5)	3230	(91.5)	3775	(106.9)
<b>Type and model</b>	B38R	5	(0.35)	810	(22.9)	1545	(43.7)	1925	(54.5)	2375	(67.2)	3135	(88.7)	4230	(119.7)	5510	(156.0)	6035	(170.8)
<b>Inlet size</b>	1-1/2" NPT	10	(0.69)	1330	(37.6)	2280	(64.5)	3515	(99.4)	4560	(129.1)	5795	(164.0)	7600	(215.2)	9690	(274.3)	10925	(309.3)
<b>Outlet size</b>	1-1/2" NPT	20	(1.38)	2090	(59.1)	3990	(112.9)	4845	(137.1)	7600	(215.2)	10450	(295.9)	12350	(349.7)	14725	(416.9)	17575	(497.6)
<b>Position</b>	11	30	(2.07)	2670	(75.6)	5415	(153.3)	8075	(228.6)	9975	(282.4)	13490	(381.9)	16625	(470.7)	19000	(538.0)	20000	(566.0)
<b>Loading ring setting</b> 0°		40	(2.76)	3325	(94.1)	6650	(188.3)	9075	(256.9)	12825	(363.1)	17575	(497.6)	19000	(538.0)	20000	(566.0)	20000	(566.0)
		50	(3.45)	3895	(110.2)	8360	(236.7)	11875	(336.2)	15200	(430.4)	19000	(538.0)	20000	(566.0)	20000	(566.0)	20000	(566.0)
		60	(4.14)	4560	(129.1)	9215	(260.9)	15675	(443.8)	19000	(538.0)	20000	(566.0)	20000	(566.0)	20000	(566.0)		
		70	(4.83)	5130	(145.2)	10770	(304.9)	15170	(429.5)	20000	(566.0)	20000	(566.0)	20000	(566.0)	20000	(566.0)		
		80	(5.52)	5690	(161.1)	12458	(352.7)	17260	(537.9)	20000	(566.0)	20000	(566.0)	20000	(566.0)				
		90	(6.21)	6270	(177.5)	13460	(381.1)	19000	(538.0)	20000	(566.0)	20000	(566.0)	20000	(566.0)				
		100	(6.90)	6840	(193.6)	16150	(457.3)	20000	(566.0)	20000	(566.0)	20000	(566.0)	20000	(566.0)				
		125	(8.63)	8235	(233.1)	19000	(538.0)	20000	(566.0)	20000	(566.0)	20000	(566.0)						

Inlet Effect A (PSIG)	0.04	0.01	0.04	0.06	0.03	0.07	0.12	0.13
Lock Up B (PSIG)	0.01	0.05	0.05	0.06	0.06	0.08	0.09	0.11

### Notes:

A. Change in outlet pressure for 10 PSIG inlet pressure change.

B. Outlet pressure increase required for lockup.

\*Individual regulator performance may vary from data shown.



Do not operate orifice in shaded inlet pressure area.

# B38 PERFORMANCE CURVES

## 2 PSIG Set Point

<b>Type and model</b>	B38R
Inlet size	2" NPT
Outlet size	2" NPT
Orifice size	3/8"
Spring	Silver

All test results are reported at a base of 14.7 PSIA at 60° F and with 0.6 S.G. gas.

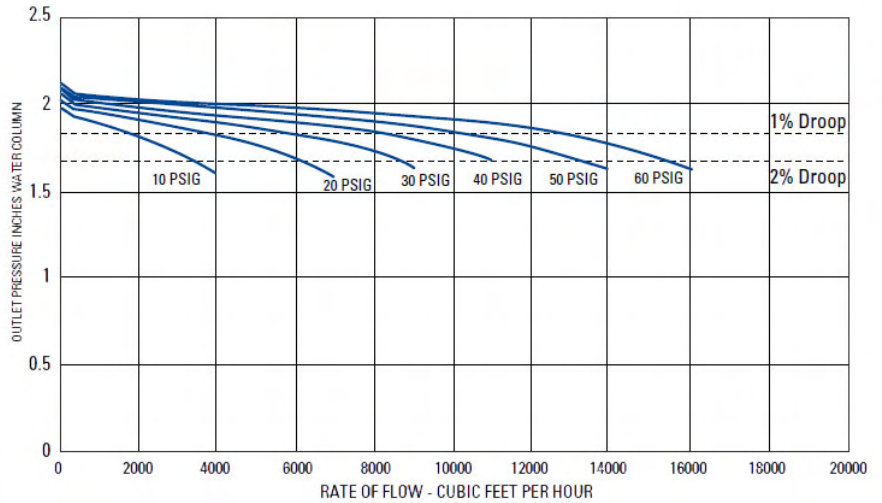

# RELIEF CURVES

## 2 PSIG Set Point

Inlet size	2" NPT
Outlet size	2" NPT
Vent size	2-1/2" NPT

All test results are reported at a base of 14.7 PSIA at 60° F and with 0.6 S.G. gas.

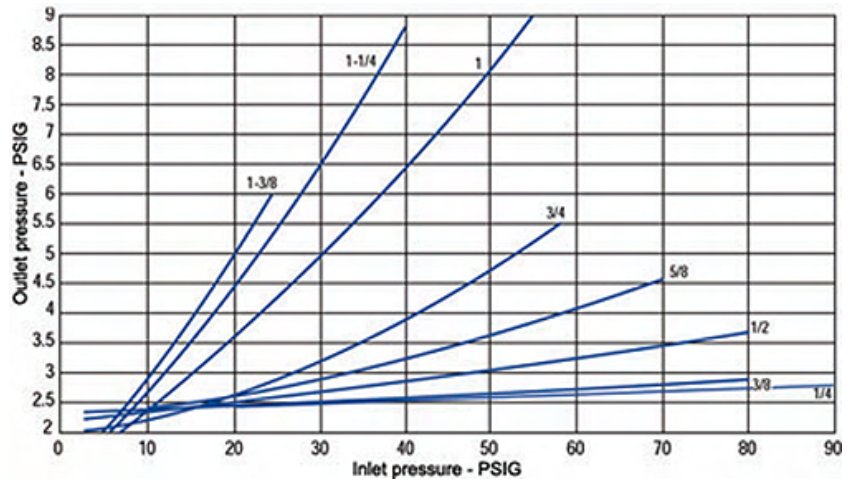

## 2 PSIG Set Point

Inlet size	2" NPT
Outlet size	2" NPT
Vent size	2" NPT

All test results are reported at a base of 14.7 PSIA at 60° F and with 0.6 S.G. gas.

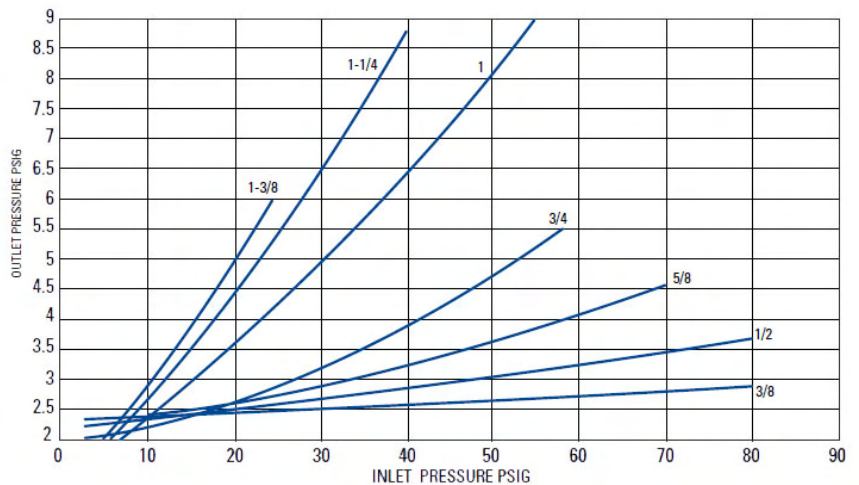



# B38 SERIES COMMERCIAL REGULATOR, MODELS N, R, M, AND D

## 5 PSIG (345 mbar) Capacity Table (1% Absolute Droop\*), 2" NPT Inlet/Outlet

Capacities in SCFH (m3/hr) of 0.6 S.G. gas; base conditions of 14.7 PSIA and 60° F.

### Typical Capacity Info.

<b>Manufacturer</b>	ROOTS Regulators
<b>Type and model</b>	B38R
<b>Inlet size</b>	2" NPT
<b>Outlet size</b>	2" NPT
<b>Position</b>	11
<b>Loading ring setting</b>	0°

Inlet Pressure		Orifice Size															
		1/4"		3/8"		1/2"		5/8"		3/4"		1"		1-1/4"		1- 3/8"	
PSIG	Bar	300	(8.4)	500	(14.0)	950	(26.6)	1000	(28.0)	1250	(35.0)	1500	(42.0)	2000	(56.0)	2250	(63.0)
10	(0.69)	700	(19.6)	1000	(28.0)	1050	(29.7)	1400	(39.2)	1700	(47.6)	2000	(56.0)	2100	(59.4)	2500	(70.0)
20	(1.38)	900	(25.2)	1100	(30.8)	1150	(32.2)	1800	(50.4)	2400	(67.2)	2800	(78.4)	3500	(99.0)	5100	(144.4)
30	(2.07)	1200	(33.6)	1500	(42.5)	1600	(44.8)	2300	(64.4)	2700	(75.6)	3600	(100.8)	6200	(175.5)	7300	(206.7)
40	(2.76)	1350	(37.8)	1700	(47.6)	3000	(84.9)	4570	(129.4)	3300	(92.4)	3700	(103.6)	6725	(190.4)	8000	(226.5)
50	(3.45)	1600	(44.8)	3200	(89.6)	3650	(102.2)	5800	(164.2)	7000	(196.0)	10000	(280.0)	9350	(264.7)		
60	(4.14)	1700	(47.6)	4000	(113.2)	4300	(121.7)	7300	(206.7)	7960	(225.4)	10000	(283.0)	11200	(317.0)		
70	(4.83)	2090	(58.5)	4200	(118.9)	4550	(128.8)	7890	(223.4)	8400	(237.8)	11100	(314.3)				
80	(5.52)	2260	(63.3)	5325	(150.7)	6850	(193.9)	8325	(235.7)	9260	(262.2)	12600	(356.8)				
90	(6.21)	2400	(67.2)	5800	(162.4)	7900	(221.2)	9160	(259.4)	10000	(283.0)	13325	(377.3)				
100	(6.90)	2750	(77.0)	7000	(196.0)	10800	(302.4)	11000	(311.4)	11300	(319.9)						
125	(8.63)																

Inlet Effect <sup>A</sup> (PSIG)	0.01	0.03	0.05	0.05	0.10	0.13	0.19	0.23
Lock Up <sup>B</sup> (PSIG)	0.07	0.08	0.11	0.11	0.11	0.18	0.20	0.22

Notes:

A. Change in outlet pressure for 10 PSIG inlet pressure change.

B. Outlet pressure increase required for lockup.

\*Individual regulator performance may vary from data shown.

 Do not operate orifice in shaded inlet pressure area.

# B38 SERIES COMMERCIAL REGULATOR, MODELS N, R, M, AND D

Capacities in SCFH (m<sup>3</sup>/hr) of 0.6 S.G. gas; base conditions of 14.7 PSIA and 60° F.

## 5 PSIG (345 mbar) Capacity Table (2% Absolute Droop\*), 2" NPT Inlet/Outlet

Typical Capacity Info.		Inlet Pressure		Orifice Size															
		PSIG	Bar	1/4"		3/8"		1/2"		5/8"		3/4"		1"		1-1/4"		1-3/8"	
<b>Manufacturer</b>	ROOTS Regulators	10	(0.69)	310	(8.7)	900	(25.2)	1750	(49.0)	2000	(56.0)	2500	(70.0)	2500	(70.0)	3500	(98.0)	4000	(112.0)
<b>Type and model</b>	B38R	20	(1.38)	1230	(34.4)	1200	(33.6)	1800	(50.4)	2700	(75.6)	3300	(92.4)	4000	(112.0)	4500	(126.0)	5200	(145.6)
<b>Inlet size</b>	2" NPT	30	(2.07)	1650	(46.2)	2300	(64.4)	2400	(67.2)	3600	(100.8)	5300	(150.0)	6200	(173.6)	7000	(196.0)	10500	(297.0)
<b>Outlet size</b>	2" NPT	40	(2.76)	2150	(60.2)	2800	(78.4)	3000	(84.0)	4100	(114.8)	6500	(182.0)	8000	(224.0)	13000	(368.0)	14000	(396.0)
<b>Position</b>	11	50	(3.45)	2550	(71.4)	3500	(98.0)	3700	(103.6)	6000	(168.0)	8500	(238.0)	9000	(252.0)	14100	(399.2)	16000	(453.0)
<b>Loading ring setting</b>	0°	60	(4.14)	3050	(85.4)	6000	(168.0)	7500	(210.0)	9800	(274.4)	11500	(322.0)	15000	(420.0)	16300	(461.5)		
		70	(4.83)	3260	(91.3)	6700	(189.7)	8300	(235.0)	11000	(311.4)	13400	(379.4)	16800	(457.7)	18000	(509.7)		
		80	(5.52)	3840	(107.5)	7100	(201.0)	9100	(257.6)	11800	(334.0)	15200	(430.4)	18400	(521.0)				
		90	(6.21)	4190	(117.3)	7950	(225.6)	10800	(305.8)	12100	(342.6)	17300	(490.0)	20000	(566.0)				
		100	(6.90)	4650	(130.2)	8500	(238.0)	13000	(364.0)	14600	(413.4)	19800	(560.6)	20000	(566.0)				
		125	(8.63)	5800	(162.4)	10300	(288.4)	16700	(467.6)	17500	(495.5)	20000	(566.0)						

Inlet Effect A (PSIG)	0.01	0.03	0.05	0.05	0.10	0.13	0.19	0.23
Lock Up B (PSIG)	0.07	0.08	0.11	0.11	0.11	0.18	0.20	0.22

Notes:

A. Change in outlet pressure for 10 PSIG inlet pressure change.

B. Outlet pressure increase required for lockup.

\*Individual regulator performance may vary from data shown.

 Do not operate orifice in shaded inlet pressure area.

# B38 SERIES COMMERCIAL REGULATOR, MODELS N, R, M, AND D

## 5 PSIG (345 mbar) Capacity Table (1% Absolute Droop\*), 1-1/2" NPT Inlet/Outlet

Capacities in SCFH (m3/hr) of 0.6 S.G. gas; base conditions of 14.7 PSIA and 60° F.

Typical Capacity Info.	
<b>Manufacturer</b>	ROOTS Regulators
<b>Type and model</b>	B38R
<b>Inlet size</b>	1-1/2" NPT
<b>Outlet size</b>	1-1/2" NPT
<b>Position</b>	11
<b>Loading ring setting</b>	0°

Inlet Pressure		Orifice Size															
		1/4"		3/8"		1/2"		5/8"		3/4"		1"		1-1/4"		1- 3/8"	
PSIG	Bar																
10	(0.69)	290	(8.2)	480	(13.6)	900	(25.4)	950	(26.9)	1190	(33.7)	1425	(40.3)	1900	(53.8)	2140	(60.5)
20	(1.38)	680	(19.2)	970	(27.4)	1000	(28.3)	1330	(37.6)	1610	(45.5)	1900	(53.8)	1915	(54.2)	2250	(63.70)
30	(2.07)	875	(24.7)	1070	(30.3)	1100	(31.0)	1710	(48.4)	2280	(64.5)	2660	(75.3)	3325	(94.0)	4890	(138.4)
40	(2.76)	1150	(32.5)	1425	(40.3)	1520	(43.0)	2185	(61.8)	2565	(72.6)	3420	(96.8)	5890	(166.7)	6950	(196.8)
50	(3.45)	1290	(36.5)	1630	(46.0)	2850	(80.7)	4345	(124.0)	4655	(131.8)	5320	(150.6)	6390	(180.9)	7600	(215.0)
60	(4.14)	1520	(43.0)	3140	(89.0)	3300	(93.4)	5510	(156.0)	6650	(188.3)	8455	(239.4)	8890	(251.7)		
70	(4.83)	1610	(45.5)	3800	(107.6)	4080	(115.5)	6935	(196.3)	7565	(214.2)	9500	(269.0)	10640	(301.0)		
80	(5.52)	1830	(51.8)	4000	(113.2)	4325	(122.4)	7500	(212.3)	7980	(225.9)	10545	(298.6)				
90	(6.21)	2250	(58.0)	5065	(143.4)	6510	(184.3)	7910	(224.0)	8800	(249.0)	11970	(339.0)				
100	(6.90)	2280	(65.4)	5510	(156.0)	7515	(212.8)	8700	(246.3)	9500	(269.0)	12660	(358.4)				
125	(8.63)	2615	(74.0)	6650	(188.3)	10300	(291.6)	10450	(296.0)	10740	(304.0)						

Inlet Effect <sup>A</sup> (PSIG)	0.01	0.03	0.05	0.05	0.10	0.13	0.19	0.23
Lock Up <sup>B</sup> (PSIG)	0.07	0.08	0.11	0.11	0.11	0.18	0.20	0.22

Notes:

A. Change in outlet pressure for 10 PSIG inlet pressure change.

B. Outlet pressure increase required for lockup.

\*Individual regulator performance may vary from data shown.

 Do not operate orifice in shaded inlet pressure area.

# B38 SERIES COMMERCIAL REGULATOR, MODELS N, R, M, AND D

## 5 PSIG (345 mbar) Capacity Table (2% Absolute Droop\*), 1-1/2" NPT Inlet/Outlet

Capacities in SCFH of 0.6 S.G. gas; base conditions of 14.7 PSIA and 60° F.

Typical Capacity Info.		Inlet Pressure		Orifice Size															
		PSIG	Bar	1/4"		3/8"		1/2"		5/8"		3/4"		1"		1-1/4"		1- 3/8"	
<b>Manufacturer</b>	ROOTS Regulators	10	(0.69)	295	(8.3)	855	(24.2)	1660	(47.0)	1900	(53.8)	2375	(67.2)	2400	(67.9)	3325	(94.1)	3800	(107.6)
<b>Type and model</b>	B38R	20	(1.38)	1170	(33.0)	1140	(32.0)	1710	(48.4)	2565	(72.6)	3135	(68.7)	3800	(107.6)	4275	(121.0)	4940	(139.8)
Inlet size	1-1/2" NPT	30	(2.07)	1570	(44.4)	2185	(61.8)	2280	(64.5)	3420	(96.8)	5035	(142.5)	5890	(166.7)	6650	(188.3)	9075	(256.9)
Outlet size	1-1/2" NPT	40	(2.76)	2040	(57.7)	2660	(75.3)	2850	(80.7)	3895	(110.0)	6175	(174.8)	7600	(215.0)	12350	(349.7)	13300	(376.6)
<b>Position</b>	11	50	(3.45)	2425	(68.6)	3325	(94.0)	3515	(99.5)	5700	(161.4)	8075	(228.6)	8550	(242.0)	13340	(377.7)	15200	(430.4)
<b>Loading ring setting</b> 0°		60	(4.14)	2900	(82.1)	5700	(161.4)	7175	(203.0)	9305	(263.4)	10925	(309.3)	13250	(375.0)	15485	(438.4)		
		70	(4.83)	3100	(87.7)	6365	(180.0)	7880	(223.0)	10450	(296.0)	12730	(360.4)	15960	(452.0)	17100	(484.2)		
		80	(5.52)	3650	(103.3)	6745	(191.0)	8645	(244.7)	11210	(317.4)	14440	(408.8)	17480	(495.0)				
		90	(6.21)	3990	(113.0)	7550	(213.7)	10260	(290.5)	11500	(325.6)	16435	(465.3)	20000	(566.0)				
		100	(6.90)	4420	(125.0)	8075	(228.6)	12350	(349.7)	13870	(392.7)	18960	(536.8)	20000	(566.0)				
		125	(8.63)	5510	(156.0)	9785	(277.0)	15865	(449.2)	16625	(470.7)	20000	(566.0)						

Inlet Effect A (PSIG)	0.01	0.03	0.05	0.05	0.10	0.13	0.19	0.23
Lock Up B (PSIG)	0.07	0.08	0.11	0.11	0.11	0.18	0.20	0.22

Notes:

A. Change in outlet pressure for 10 PSIG inlet pressure change.

B. Outlet pressure increase required for lockup.

\*Individual regulator performance may vary from data shown.

 Do not operate orifice in shaded inlet pressure area.

# B38 PERFORMANCE CURVES

## 5 PSIG Set Point

<b>Type and model</b>	B38R
Inlet size	2" NPT
Outlet size	2" NPT
Orifice size	3/8"
Spring	Red nested

All test results are reported at a base of 14.7 PSIA at 60° F and with 0.6 S.G. gas.

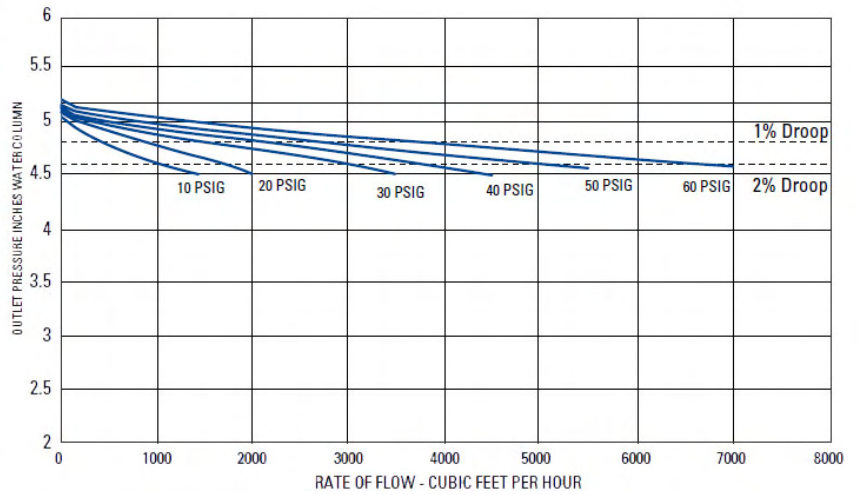

## RELIEF CURVES

### 5 PSIG Set Point

Inlet size	2" NPT
Outlet size	2" NPT
Vent size	2-1/2" NPT

All test results are reported at a base of 14.7 PSIA at 60° F and with 0.6 S.G. gas.

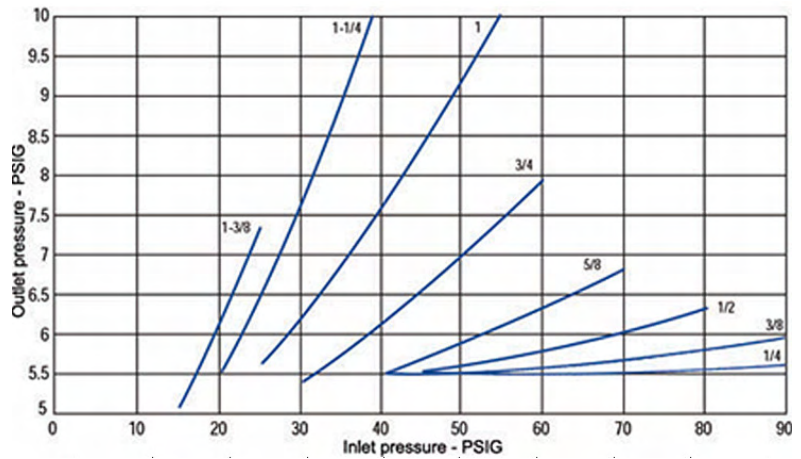

### 5 PSIG Set Point

Inlet size	2" NPT
Outlet size	2" NPT
Vent size	2" NPT

All test results are reported at a base of 14.7 PSIA at 60° F and with 0.6 S.G. gas.

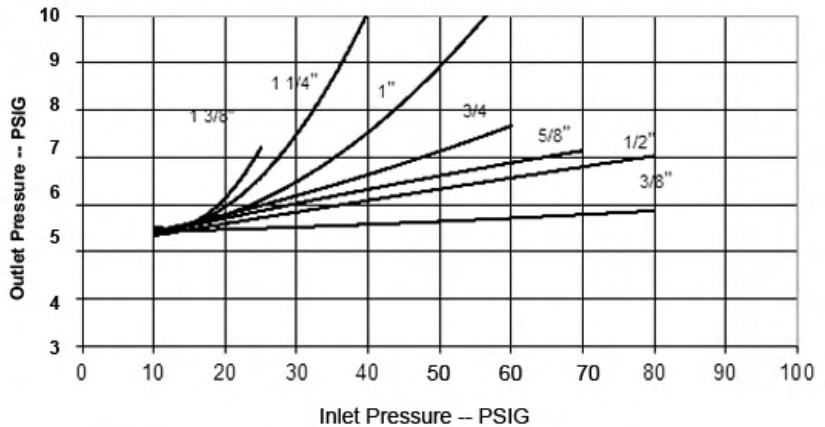

## B38 COMMERCIAL AND INDUSTRIAL REGULATOR IMN & IMR

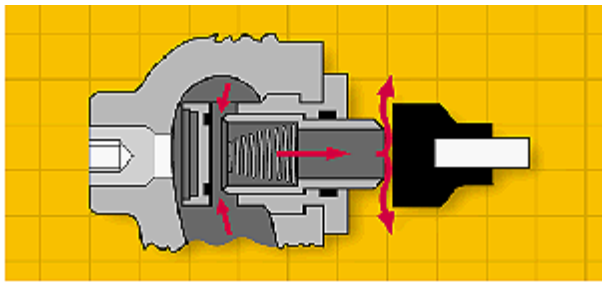

**A. Standard regulator and upstream monitor orifice**

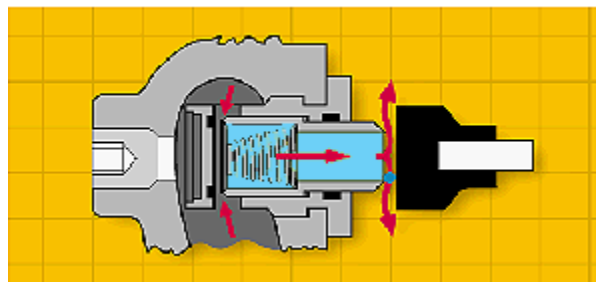

**B. Standard regulator orifice failed; upstream monitor orifice control**

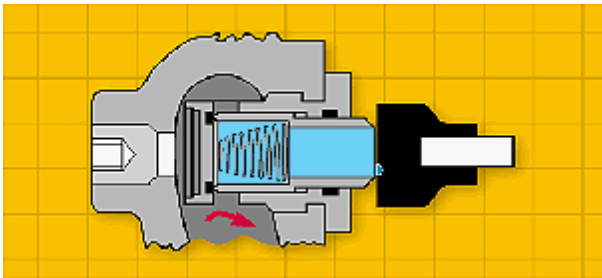

**C. Main orifice failed; upstream monitor orifice "lock-up"**

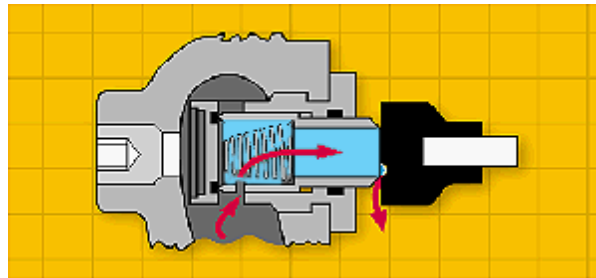

**D. V option; vents a small volume of gas to the atmosphere through the relief valve**

### PRINCIPLE OF OPERATION

**A. Normal operation.** The internal monitor IM orifice performs like a standard regulator and monitor regulator in that the main orifice and valve seat actuate to control outlet flow and pressure under normal flow conditions. If there is no demand, the main seat and internal monitor orifice will close.

**B. Monitor operation.** If the main valve seat fails to control the gas flow and pressure due to foreign matter between the seat and orifice face, or if the seat is eroded, the internal monitor orifice automatically goes into operating position at a slightly higher outlet pressure (see Internal Monitor Lock-up Pressure table). Any time the pressure on the main diaphragm exceeds the force of the fixed monitor spring, the increased outlet pressure causes the main valve seat to push against the sliding orifice. The sliding orifice compresses the monitor spring and positions the monitor orifice to control the gas flow. The IM orifice now functions as a monitor regulator and continues to monitor as long as the main seat fails to control at the normal adjusted outlet pressure. If the gas load demand is increased beyond the internal monitor's capacity, the outlet pressure is reduced to normal adjusted pressure and the regulator resumes normal regulation.

**C. Monitor lock-up.** If the demand for gas is decreased to zero flow during monitor operation, the sliding orifice continues to close until its orifice is in the gas tight position (monitor lock-up) against the BUNA-N monitor valve seat. (See the Internal Monitor Lock-up Pressure table for the outlet pressure required for internal monitor lock-up.)

**D. Vent hole V option.** On installations where a small volume of over-pressure gas can be safely vented to the atmosphere, the advantages of both the relief valve and monitor safety can be combined. If the flow is decreased to zero or just greater than zero, the vent hole in the internal monitor orifice allows gas to slowly bleed downstream and cause the pressure to rise to the relief point of the internal relief valve. The gas then bleeds to the atmosphere indicating a problem with the regulator.

### INTERNAL MONITOR LOCK-UP AND RELIEF PRESSURE DATA

Main Spring Color	Outlet Pressure Set Point	IM Lock-up Pressure Models B38 IMN & IMR	Relief Pressure Model B38 IMRV
Brown	5.5" w.c.	11.0" w.c.	15.0" w.c.
Green/White	7.0" w.c.	12.5" w.c.	17.0" w.c.
Black R Models	11.0" w.c.	19.0" w.c.	22.5" w.c.
Black N Models	14.0" w.c.	23.5" w.c.	29.5" w.c.
Blue	14.0" w.c.	23.5" w.c.	29.5" w.c.
Purple	14.0" w.c.	24" w.c.	30" w.c.
Blue/White	1.0 PSIG	1.5 PSIG	1.9 PSIG
Silver/Red	2.0 PSIG	3.0 PSIG	3.8 PSIG
Yellow	3.0 PSIG	4.0 PSIG	5.0 PSIG
Red Nested	5.0 PSIG	6.2 PSIG	8.4 PSIG

Adjusted outlet pressure range spring adjustment ferrule at min. and max. depths\*.

# B38 SERIES COMMERCIAL REGULATOR

## IM Spring Data, Spring Color Outlet Pressure Range

Adjusted outlet pressure range spring adjustment ferrule at min. and max. depths\*.

Orifice Size	Inlet Pressure	Outlet Pressure		
		Spring Color	Minimum	Maximum
3/8"	25 PSIG	Orange	2.8" w.c.	4.1" w.c.
		Brown	4.2" w.c.	6.9" w.c.
		Green/white	5.3" w.c.	8.1" w.c.
		Black	7.0" w.c.	12.6" w.c.
		Purple	11.1" w.c.	19.1" w.c.
		Blue/white	0.50 PSIG	1.02 PSIG
		Silver/red	1.21 PSIG	2.06 PSIG
		Yellow	1.57 PSIG	3.56 PSIG
		Red	2.23 PSIG	5.03 PSIG
1/2"	25 PSIG	Orange	2.8" w.c.	4.2" w.c.
		Brown	4.2" w.c.	7.0" w.c.
		Green/white	5.3" w.c.	8.2" w.c.
		Black	7.2" w.c.	12.9" w.c.
		Purple	11.7" w.c.	19.3" w.c.
		Blue/white	0.51 PSIG	1.0 PSIG
		Silver/red	1.21 PSIG	2.6 PSIG
		Yellow	1.57 PSIG	3.64 PSIG
		Red	2.26 PSIG	5.03 PSIG
5/8"	25 PSIG	Orange	3.3" w.c.	4.6" w.c.
		Brown	4.6" w.c.	7.3" w.c.
		Green/white	6.1" w.c.	8.7" w.c.
		Black	8.1" w.c.	13.6" w.c.
		Purple	12.3" w.c.	20.0" w.c.
		Blue/white	0.57 PSIG	1.05 PSIG
		Silver/red	1.29 PSIG	2.19 PSIG
		Yellow	1.78 PSIG	3.88 PSIG
		Red	2.48 PSIG	5.18 PSIG
3/4"	25 PSIG	Orange	3.6" w.c.	4.8" w.c.
		Brown	5.2" w.c.	7.8" w.c.
		Green/white	6.6" w.c.	9.2" w.c.
		Black	8.2" w.c.	14.1" w.c.
		Purple	12.7" w.c.	20.7" w.c.
		Blue/white	0.57 PSIG	1.07 PSIG
		Silver/red	1.31 PSIG	2.23 PSIG
		Yellow	1.77 PSIG	3.79 PSIG
		Red	2.47 PSIG	5.13 PSIG
1"	10 PSIG	Orange	3.3" w.c.	4.9" w.c.
		Brown	5.1" w.c.	7.7" w.c.
		Green/white	6.2" w.c.	8.8" w.c.
		Black	8.3" w.c.	13.95" w.c.
		Purple	14.2" w.c.	21.8" w.c.
		Blue/white	0.57 PSIG	1.07 PSIG
		Silver/red	1.28 PSIG	2.24 PSIG
		Yellow	1.73 PSIG	3.80 PSIG
		Red	2.44 PSIG	5.06 PSIG

\*Maximum allowable pressure is 5.00 PSIG.

<b>Outlet Pressure Change as a Result Orifice of a 10 PSIG Inlet P Size ressure Change</b>					
Spring Color	3/8"	1/2"	5/8"	3/4"	1"
Orange	0.11" w.c.	0.22" w.c.	0.32" w.c.	0.47" w.c.	0.86" w.c.
Brown	0.13" w.c.	0.23" w.c.	0.40" w.c.	0.50" w.c.	0.95" w.c.
Green/white	0.17" w.c.	0.23" w.c.	0.40" w.c.	0.50" w.c.	1.00" w.c.
Black	0.17" w.c.	0.23" w.c.	0.42" w.c.	0.50" w.c.	1.00" w.c.
Purple	0.19" w.c.	0.27" w.c.	0.45" w.c.	0.55" w.c.	1.15" w.c.
Blue/white	0.01 PSIG	0.01 PSIG	0.02 PSIG	0.02 PSIG	0.04 PSIG
Silver/red	0.01 PSIG	0.01 PSIG	0.02 PSIG	0.02 PSIG	0.05 PSIG
Yellow	0.01 PSIG	0.02 PSIG	0.02 PSIG	0.03 PSIG	0.06 PSIG
Red	0.01 PSIG	0.02 PSIG	0.02 PSIG	0.03 PSIG	0.07 PSIG

<b>B-38 IMRV Flow Chart</b>		
Vented gas flow of the IMRV if the main valve seat failed and the internal monitor is operating.	Inlet Pressure (PSIG)	Flow (SCFH)
	20	60
	40	90
	60	120
	75	150
	100	190
	125	230



# B38 SERIES COMMERCIAL REGULATOR, MODELS IM

7" w.c. (17 mbar) Capacity Table (1" Droop\*), 2" Inlet/Outlet

Capacities in SCFH (m3/hr) of 0.6 S.G. gas; base conditions of 14.7 PSIA and 60° F.

Typical Capacity Info.	
<b>Manufacturer</b>	ROOTS Regulators
<b>Type and model</b>	B38IM
Inlet size	2" NPT
Outlet size	2" NPT
<b>Position</b>	11
<b>Loading ring setting</b>	-40°

Inlet Pressure		Orifice Size									
PSIG	Bar	3/8"		1/2"		5/8"		3/4"		1"	
1	(0.07)	400	(11.2)	650	(18.2)	1000	(28.0)	1200	(33.6)	1600	(44.8)
2	(0.14)	750	(21.0)	1150	(32.2)	2100	(58.8)	2300	(64.4)	3000	(84.0)
3	(0.21)	1000	(28.0)	1650	(46.2)	2800	(78.4)	3800	(106.4)	4000	(112.0)
5	(0.35)	1500	(42.0)	2200	(61.6)	3800	(106.4)	6100	(170.8)	5300	(148.4)
10	(0.69)	2400	(67.2)	3600	(100.8)	6100	(170.8)	8300	(232.4)	8800	(246.4)
15	(1.03)	3200	(89.6)	5000	(140.0)	8300	(232.4)	9500	(266.0)	10500	(294.0)
20	(1.38)	4400	(123.2)	6000	(168.0)	9500	(266.0)	11500	(322.0)	12000	(340.0)
25	(1.72)	5000	(140.0)	6700	(187.6)	11500	(322.0)	12500	(350.0)	15000	(420.0)
30	(2.07)	5500	(154.0)	7000	(196.0)	12500	(350.0)	14500	(406.0)	17000	(476.0)
40	(2.76)	7000	(196.0)	8000	(224.0)	14500	(406.0)	15000	(420.0)		
50	(3.45)	8000	(224.0)	8200	(229.6)	15000	(420.0)	16000	(448.0)		
60	(4.14)	8560	(239.0)	8900	(249.2)	16800	(475.7)	20000	(566.0)		
70	(4.83)	9095	(254.7)	9630	(269.6)						
75	(5.17)	9850	(285.0)	10500	(294.0)						
80	(5.52)	10170	(284.8)	12000	(340.0)						
90	(6.21)	10325	(289.1)	16000	(448.0)						
95	(6.55)	13500	(378.0)	20000	(566.0)						
100	(6.90)	15470	(433.2)	20000	(566.0)						
125	(8.63)	17000	(476.0)	20000	(566.0)						

Inlet Effect A (in w.c.)	0.2	0.2	0.4	0.5	1.0
Lock Up B (in w.c.)	0.2	0.2	0.4	0.8	1.0

Notes:

A. Change in outlet pressure for 10 PSIG inlet pressure change.

B. Outlet pressure increase required for lockup.

\*Individual regulator performance may vary from data shown. Max. capacities on inches w.c. outlet

1-1/2: outlet connection - 12,000 SCFH

2" outlet connection - 20,000 SCFH

3" outlet connection (2" I.P.S.) - 20,000 SCFH

 Do not operate orifice in shaded inlet pressure area.

# B38 SERIES COMMERCIAL REGULATOR

7" w.c. (17 mbar) Capacity Table (1" Droop\*), 1-1/2" Inlet/Outlet

Typical Capacity Info.	
<b>Manufacturer</b>	ROOTS Regulators
<b>Type and model</b>	B38IM
<b>Inlet size</b>	1-1/2" NPT
<b>Outlet size</b>	1-1/2" NPT
<b>Position</b>	11
<b>Loading ring setting</b>	-40°

Inlet Pressure		Orifice Size									
PSIG	Bar	3/8"		1/2"		5/8"		3/4"		1"	
1	(0.07)	400	(11.2)	630	(17.8)	1000	(28.0)	1200	(33.6)	1500	(42.4)
2	(0.14)	680	(19.2)	1150	(32.2)	1680	(47.5)	2000	(56.6)	2500	(70.7)
3	(0.21)	1000	(28.0)	1550	(43.8)	2300	(65.1)	2500	(70.7)	3400	(96.2)
5	(0.35)	1500	(42.0)	1950	(55.2)	2400	(67.9)	3100	(87.7)	3800	(107.6)
10	(0.69)	2300	(65.1)	3400	(96.2)	5800	(164.2)	6300	(178.3)	8000	(226.5)
15	(1.03)	2900	(82.1)	4300	(121.7)	7500	(212.3)	7600	(215.2)	9600	(271.8)
20	(1.38)	3400	(96.2)	5000	(141.5)	8000	(226.5)	9200	(260.5)	10450	(295.9)
25	(1.72)	3800	(107.6)	5500	(155.7)	10200	(288.8)	12000	(340.0)	12000	(340.0)
30	(2.07)	4300	(121.7)	5800	(164.2)	11300	(319.9)	12000	(340.0)	12000	(340.0)
40	(2.76)	4900	(138.7)	5900	(167.0)	11900	(336.9)	12000	(340.0)		
50	(3.45)	5500	(155.7)	6000	(169.9)	12000	(340.0)	12000	(340.0)		
60	(4.14)	6400	(181.2)	6500	(184.0)	12000	(340.0)	12000	(340.0)		
70	(4.83)	7100	(201.0)	7200	(203.8)						
75	(5.17)	7350	(208.1)	9000	(254.8)						
80	(5.52)	7900	(223.7)	9900	(280.3)						
90	(6.21)	8100	(229.3)	12000	(340.0)						
95	(6.55)	9900	(280.3)	12000	(340.0)						
100	(6.90)	12000	(340.0)	12000	(340.0)						
125	(8.63)	12000	(340.0)	12000	(340.0)						

Inlet Effect A (in w.c.)	0.2	0.2	0.4	0.5	1.0
Lock Up B (in w.c.)	0.2	0.2	0.4	0.8	1.0

Notes:

A. Change in outlet pressure for 10 PSIG inlet pressure change.

B. Outlet pressure increase required for lockup.

\*Individual regulator performance may vary from data shown. Max. capacities on inches w.c. outlet

1-1/2: outlet connection - 12,000 SCFH

2" outlet connection - 20,000 SCFH

3" outlet connection (2" I.P.S.) - 20,000 SCFH

 Do not operate orifice in shaded inlet pressure area.

## B38 PERFORMANCE CURVES

### 7" w.c. Set Point

**Type and model** B38IMR

Inlet size 2" NPT

Outlet size 2" NPT

Orifice size 3/8"

Spring Green/white

All test results are reported at a base of 14.7 PSIA at 60° F and with 0.6 S.G. gas.

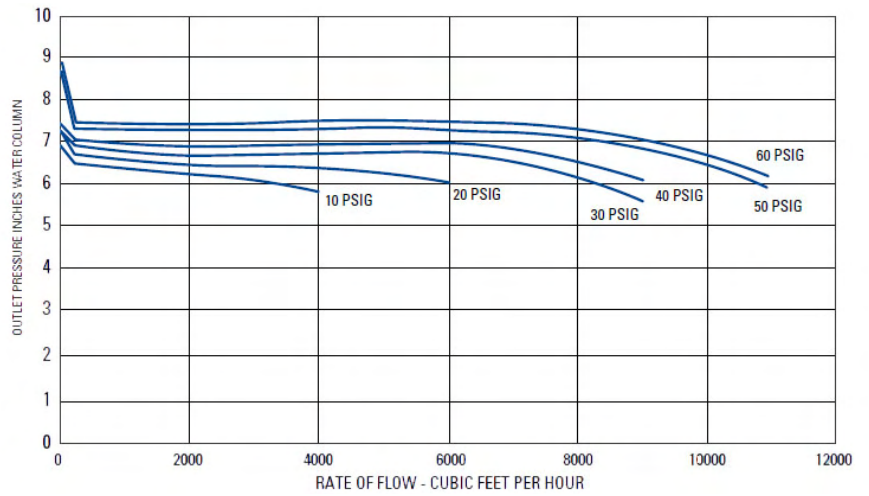

## RELIEF CURVES

### 7" w.c. Set Point

Inlet size 2" NPT

Outlet size 2" NPT

Vent size 2-1/2" NPT

All test results are reported at a base of 14.7 PSIA at 60° F and with 0.6 S.G. gas.

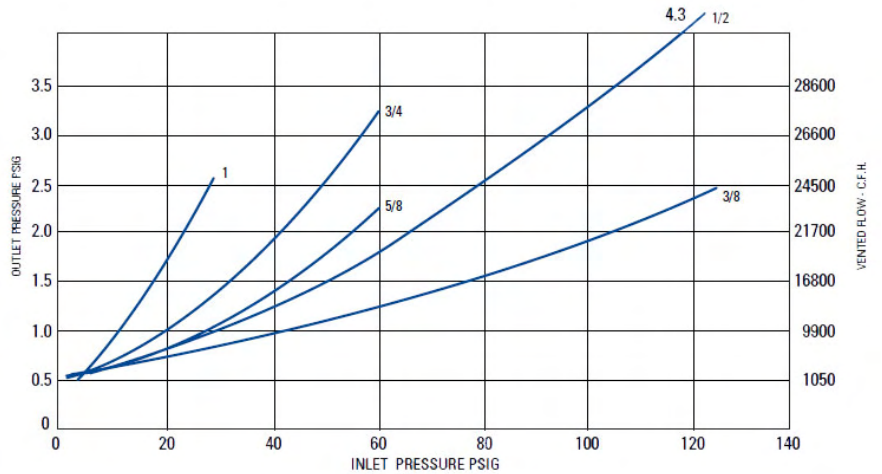

# B38 SERIES COMMERCIAL REGULATOR, MODELS IM

## 14" w.c. (17 mbar) Capacity Table (2" Droop\*), 2" Inlet/Outlet

Capacities in SCFH (m3/hr) of 0.6 S.G. gas; base conditions of 14.7 PSIA and 60° F.

Typical Capacity Info.		Inlet Pressure		Orifice Size									
		PSIG	Bar	3/8"		1/2"		5/8"		3/4"		1"	
<b>Manufacturer</b>	ROOTS Regulators	1	(0.07)	450	(12.7)	630	(17.8)	1070	(30.2)	1200	(33.9)	1570	(44.4)
		2	(0.14)	630	(17.8)	1110	(31.4)	1840	(52.1)	1970	(55.7)	2480	(70.2)
<b>Type and model</b>	B38IM	3	(0.21)	1000	(28.3)	1400	(39.6)	2200	(62.2)	2500	(70.7)	2950	(83.5)
<b>Inlet size</b>	2" NPT	5	(0.35)	1320	(37.3)	1860	(52.6)	3150	(89.1)	3200	(90.6)	4650	(131.6)
<b>Outlet size</b>	2" NPT	10	(0.69)	2040	(57.7)	2850	(80.7)	5080	(143.8)	5750	(162.8)	6580	(186.3)
<b>Position</b>	11	15	(1.03)	2550	(72.2)	4100	(116.0)	7030	(199.0)	7450	(210.9)	9050	(256.2)
<b>Loading ring setting</b>	0°	20	(1.38)	3600	(101.9)	5200	(147.2)	9300	(263.3)	10000	(283.1)	11250	(318.5)
		25	(1.72)	4900	(138.7)	6500	(184.0)	11250	(318.5)	12000	(339.8)	14900	(421.9)
		30	(2.07)	5400	(152.9)	7350	(208.1)	13250	(375.1)	14000	(396.4)	15500	(438.9)
		40	(2.76)	6900	(195.3)	7950	(225.1)	14200	(402.0)	14800	(419.0)		
		50	(3.45)	7700	(218.0)	8000	(226.5)	14600	(413.4)	15800	(447.4)		
		60	(4.14)	8490	(240.4)	8600	(243.5)	16500	(467.2)	20000	(566.0)		
		70	(4.83)	8950	(253.4)	9400	(266.1)						
		75	(5.17)	9725	(275.3)	10200	(288.8)						
		80	(5.52)	10000	(283.1)	11800	(334.1)						
		90	(6.21)	10100	(286.0)	14950	(423.3)						
		95	(6.55)	13150	(372.3)	20000	(566.0)						
		100	(6.90)	15100	(427.5)	20000	(566.0)						
		125	(8.63)	1680	(475.7)	20000	(566.0)						

Inlet Effect A (in w.c.)	0.2	0.2	0.4	0.5	1.0
Lock Up B (in w.c.)	0.2	0.2	0.4	0.8	1.0

### Notes

A. Change in outlet pressure for 10 PSIG inlet pressure change.

B. Outlet pressure increase required for lockup.

\*Individual regulator performance may vary from data shown. Max. capacities on inches w.c. outlet

1-1/2" outlet connection - 12,000 SCFH

2" outlet connection - 20,000 SCFH

3" outlet connection (2" I.P.S.) - 20,000 SCFH

 Do not operate orifice in shaded inlet pressure area.

# B38 SERIES COMMERCIAL REGULATOR, MODELS IM

## 14" w.c. (17 mbar) Capacity Table (2" Droop\*), 1-1/2" Inlet/Outlet

Capacities in SCFH (m3/hr) of 0.6 S.G. gas; base conditions of 14.7 PSIA and 60° F.

Typical Capacity Info.		Inlet Pressure		Orifice Size									
		PSIG	Bar	3/8"		1/2"		5/8"		3/4"		1"	
<b>Manufacturer</b>	ROOTS Regulators	1	(0.07)	430	(12.1)	600	(16.9)	1020	(28.8)	1140	(32.2)	1495	(42.3)
		2	(0.14)	600	(16.9)	1060	(30.0)	1750	(49.5)	1890	(53.5)	2360	(66.8)
<b>Type and model</b>	B38IM	3	(0.21)	950	(26.9)	1330	(37.6)	2090	(59.1)	2375	(67.2)	2800	(79.2)
Inlet size	1-1/2" NPT	5	(0.35)	1255	(35.5)	1770	(50.1)	3000	(84.9)	3040	(86.0)	4420	(125.1)
Outlet size	1-1/2" NPT	10	(0.69)	1940	(54.9)	2710	(76.7)	4830	(136.7)	5465	(154.7)	6250	(176.9)
<b>Position</b>	11	15	(1.03)	2425	(68.6)	3895	(110.2)	6680	(189.1)	7080	(200.4)	8600	(243.5)
<b>Loading ring setting</b>	0°	20	(1.38)	3420	(96.8)	4940	(139.8)	8835	(250.1)	9500	(269.0)	10690	(302.7)
		25	(1.72)	4655	(131.8)	6175	(174.8)	10690	(302.7)	11400	(322.8)	14155	(400.8)
		30	(2.07)	5130	(145.2)	6990	(197.9)	12600	(356.7)	13300	(376.6)	14725	(416.9)
		40	(2.76)	6555	(185.6)	7550	(213.7)	13490	(381.9)	14060	(398.1)		
		50	(3.45)	7320	(207.2)	7600	(215.2)	13870	(392.7)	15010	(425.0)		
		60	(4.14)	8065	(228.3)	8170	(231.3)	15675	(443.8)	19000	(538.0)		
		70	(4.83)	8500	(240.6)	8930	(252.8)						
		75	(5.17)	9240	(261.6)	9700	(274.6)						
		80	(5.52)	9500	(269.0)	11210	(317.4)						
		90	(6.21)	9600	(271.8)	14200	(402.0)						
		95	(6.55)	12500	(353.9)	19000	(538.0)						
		100	(6.90)	14350	(406.3)	20000	(566.0)						
		125	(8.63)	15960	(451.9)	20000	(566.0)						

Inlet Effect A (in w.c.)	0.2	0.2	0.4	0.5W	1.0
Lock Up B (in w.c.)	0.2	0.2	0.4	0.8	1.0

Notes:

A. Change in outlet pressure for 10 PSIG inlet pressure change.

B. Outlet pressure increase required for lockup.

\*Individual regulator performance may vary from data shown. Max. capacities on inches w.c. outlet

1-1/2: outlet connection - 12,000 SCFH

2" outlet connection - 20,000 SCFH

3" outlet connection (2" I.P.S.) - 20,000 SCFH

Do not operate orifice in shaded inlet pressure area.

## B38 PERFORMANCE CURVES

### 14" w.c. Set Point

<b>Type and model</b>	B38IMR
Inlet size	2" NPT
Outlet size	2" NPT
Orifice size	1/2"
Spring	Black

All test results are reported at a base of 14.7 PSIA at 60° F and with 0.6 S.G. gas.

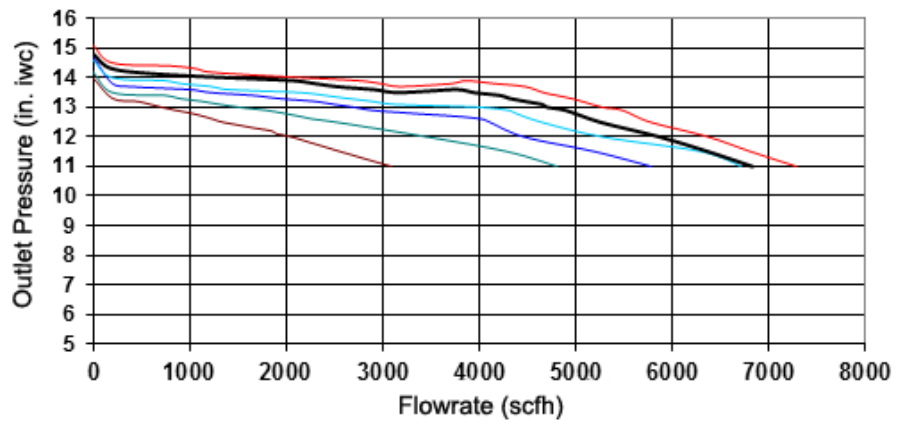

## RELIEF CURVES

### 14" w.c. Set Point

Inlet size	2" NPT
Outlet size	2" NPT
Vent size	2-1/2" NPT

All test results are reported at a base of 14.7 PSIA at 60° F and with 0.6 S.G. gas.

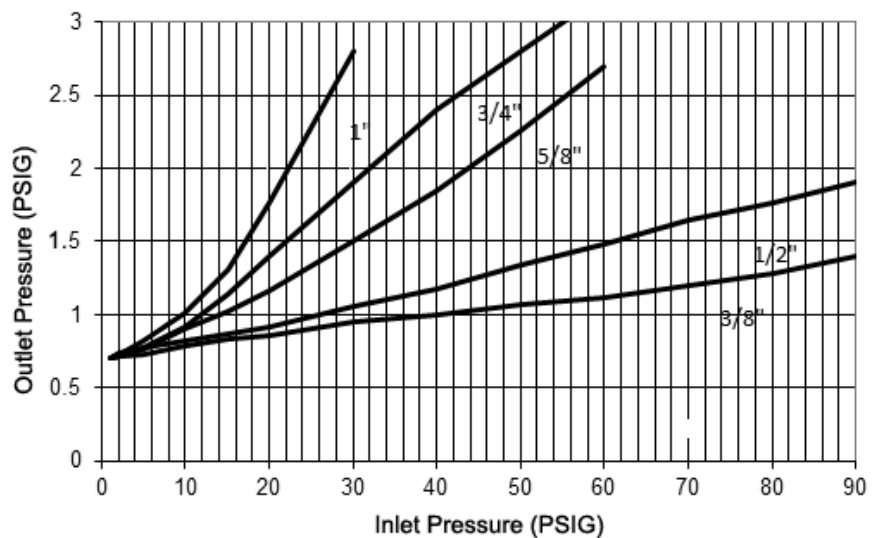

# B38 SERIES COMMERCIAL REGULATOR

## 1 PSIG (69 mbar) Capacity Table (1% Absolute Droop\*), 2" Inlet/Outlet

Capacities in SCFH (m3/hr) of 0.6 S.G. gas; base conditions of 14.7 PSIA and 60° F.

Typical Capacity Info.		Inlet Pressure		Orifice Size									
		PSIG	Bar	3/8"		1/2"		5/8"		3/4"		1"	
<b>Manufacturer</b>	ROOTS Regulators	2	(0.14)	500	(14.0)	700	(19.6)	1600	(44.8)	1700	(47.6)	2400	(67.2)
<b>Type and model</b>	B38IM	3	(0.21)	750	(21.0)	1200	(33.6)	2000	(56.0)	2300	(64.4)	2900	(81.2)
<b>Inlet size</b>	2" NPT	5	(0.35)	1400	(39.2)	1900	(53.2)	3000	(84.0)	3300	(92.4)	4200	(117.6)
<b>Outlet size</b>	2" NPT	10	(0.69)	2000	(56.0)	2900	(81.2)	4800	(134.4)	6000	(169.8)	7000	(196.0)
<b>Position</b>	11	20	(1.38)	3500	(98.0)	5100	(142.8)	8300	(232.4)	9500	(266.0)	11300	(316.4)
<b>Loading ring setting</b>	0°	30	(2.07)	5000	(140.0)	7000	(196.0)	11300	(316.4)	12300	(344.4)	15000	(420.0)
		40	(2.76)	6000	(168.0)	9000	(252.0)	14000	(392.0)	15700	(439.6)	16400	(420.0)
		50	(3.45)	8500	(238.0)	11000	(308.0)	16500	(462.0)	17200	(481.6)	18600	(526.6)
		60	(4.14)	9600	(268.8)	12700	(355.6)	18000	(504.0)	19500	(546.0)	20000	(566.0)
		70	(4.83)	11235	(314.6)	14980	(419.4)	19600	(555.0)	20000	(566.0)	20000	(566.0)
		80	(5.52)	12995	(363.9)	16159	(452.5)	20000	(566.0)	20000	(566.0)	20000	(566.0)
		90	(6.21)	13924	(389.9)	17100	(479.1)	20000	(566.0)	20000	(566.0)	20000	(566.0)
		100	(6.90)	14500	(410.5)	20000	(566.0)	20000	(566.0)	20000	(566.0)	20000	(566.0)
		125	(8.63)	18300	(518.0)	20000	(566.0)	20000	(566.0)	20000	(566.0)		

Inlet Effect A (PSIG)	0.01	0.01	0.02	0.02	0.04
Lock Up B (PSIG)	0.02	0.05	0.06	0.09	0.12

Notes:

A Change in outlet pressure for 10 PSIG inlet pressure change.

B. Outlet pressure increase required for lockup.

\*Individual regulator performance may vary from data shown.

 Do not operate orifice in shaded inlet pressure area.

# B38 SERIES COMMERCIAL REGULATOR

## 1 PSIG (69 mbar) Capacity Table (2% Absolute Droop\*), 2" Inlet/Outlet

Capacities in SCFH of 0.6 S.G. gas; base conditions of 14.7 PSIA and 60° F.

Typical Capacity Info.		Inlet Pressure		Orifice Size									
		PSIG	Bar	3/8"		1/2"		5/8"		3/4"		1"	
<b>Manufacturer</b>	ROOTS Regulators	2	(0.14)	750	(21.0)	1200	(33.6)	2000	(56.0)	2300	(64.4)	3300	(92.4)
<b>Type and model</b>	B38IM	3	(0.21)	900	(25.2)	1700	(47.6)	2600	(72.8)	3100	(86.8)	4000	(112.0)
<b>Inlet size</b>	2" NPT	5	(0.35)	1900	(53.2)	2300	(64.4)	4000	(112.0)	4400	(123.2)	5800	(162.4)
<b>Outlet size</b>	2" NPT	10	(0.69)	2700	(75.6)	3600	(100.8)	6400	(179.2)	7300	(204.4)	9000	(252.0)
<b>Position</b>	11	20	(1.38)	4300	(120.4)	6300	(176.4)	10000	(280.0)	11500	(322.0)	14000	(392.0)
<b>Loading ring setting</b>	-0°	30	(2.07)	6100	(170.8)	8500	(238.0)	13500	(378.0)	15000	(420.0)	18200	(509.6)
		40	(2.76)	7500	(210.0)	10500	(294.0)	16500	(462.0)	18000	(504.0)	19500	(552.0)
		50	(3.45)	9000	(252.0)	12500	(350.0)	20000	(566.0)	20000	(566.0)	20000	(566.0)
		60	(4.14)	10300	(288.4)	14300	(400.4)	20000	(566.0)	20000	(566.0)	20000	(566.0)
		70	(4.83)	11663	(326.6)	16050	(449.4)	20000	(566.0)	20000	(566.0)	20000	(566.0)
		80	(5.52)	13221	(370.2)	17515	(490.4)	20000	(566.0)	20000	(566.0)	20000	(566.0)
		90	(6.21)	14160	(396.5)	19470	(545.2)	20000	(566.0)	20000	(566.0)	20000	(566.0)
		100	(6.90)	15700	(439.6)	20000	(566.0)	20000	(566.0)	20000	(566.0)	20000	(566.0)
		125	(8.63)	19200	(537.6)	20000	(566.0)	20000	(566.0)	20000	(566.0)		

Inlet Effect A (PSIG)	0.01	0.01	0.02	0.02	0.04
Lock Up B (PSIG)	0.02	0.05	0.06	0.09	0.12

**Notes:**

A Change in outlet pressure for 10 PSIG inlet pressure change.

B. Outlet pressure increase required for lockup.

\*Individual regulator performance may vary from data shown.



Do not operate orifice in shaded inlet pressure area.



# B38 SERIES COMMERCIAL REGULATOR, MODELS IMN, IMR, AND IMRV

## 1 PSIG (69 mbar) Capacity Table (1% Absolute Droop\*), 1-1/2" Inlet/Outlet

Capacities in SCFH (m3/hr) of 0.6 S.G. gas; base conditions of 14.7 PSIA and 60° F.

Typical Capacity Info.		Inlet Pressure		Orifice Size									
		PSIG	Bar	3/8"		1/2"		5/8"		3/4"		1"	
<b>Manufacturer</b>	ROOTS Regulators	2	(0.14)	475	(13.4)	665	(18.8)	1520	(43.0)	1615	(45.7)	2280	(64.5)
		3	(0.21)	715	(20.2)	1140	(32.3)	1900	(53.8)	2185	(61.8)	2755	(78.0)
<b>Type and model</b>	B38IM	5	(0.35)	1330	(37.6)	1805	(51.1)	2850	(60.7)	3135	(88.8)	3990	(113.0)
<b>Inlet size</b>	1-1/2" NPT	10	(0.69)	1900	(53.8)	2845	(80.6)	4260	(120.6)	5700	(161.4)	6650	(188.3)
<b>Outlet size</b>	1-1/2" NPT	20	(1.38)	3325	(94.1)	4845	(137.2)	7885	(223.3)	9025	(255.6)	10735	(304.0)
<b>Position</b>	11	30	(2.07)	4750	(134.5)	6650	(188.3)	10735	(304.0)	11685	(330.9)	14250	(403.5)
<b>Loading ring setting</b>	-0°	40	(2.76)	5700	(161.4)	8850	(250.6)	13300	(376.6)	15035	(425.7)	15580	(441.1)
		50	(3.45)	8075	(228.6)	10450	(296.0)	15675	(443.8)	16340	(462.7)	17670	(500.3)
		60	(4.14)	9120	(258.2)	12065	(341.6)	17100	(484.2)	18525	(524.6)	19000	(538.0)
		70	(4.83)	10675	(302.2)	14230	(403.0)	18620	(527.2)	20000	(566.0)	20000	(566.0)
		80	(5.52)	12345	(349.6)	15350	(434.6)	19000	(538.0)	20000	(566.0)	20000	(566.0)
		90	(6.21)	13230	(374.6)	16255	(460.2)	20000	(566.0)	20000	(566.0)	20000	(566.0)
		100	(6.90)	13775	(390.0)	20000	(566.0)	20000	(566.0)	20000	(566.0)	20000	(566.0)
		125	(8.63)	17385	(492.2)	20000	(566.0)	20000	(566.0)	20000	(566.0)		

Inlet Effect A (PSIG)	0.01	0.01	0.02	0.02	0.04
Lock Up B (PSIG)	0.02	0.05	0.06	0.09	0.12

**Notes:**

A Change in outlet pressure for 10 PSIG inlet pressure change.

B. Outlet pressure increase required for lockup.

\*Individual regulator performance may vary from data shown.



Do not operate orifice in shaded inlet pressure area.

# B38 SERIES COMMERCIAL REGULATOR, MODELS IMN, IMR, AND IMRV

## 1 PSIG (69 mbar) Capacity Table (2% Absolute Droop\*), 1-1/2" Inlet/Outlet

Capacities in SCFH (m3/hr) of 0.6 S.G. gas; base conditions of 14.7 PSIA and 60° F.

Typical Capacity Info.		Inlet Pressure		Orifice Size									
		PSIG	Bar	3/8"		1/2"		5/8"		3/4"		1"	
<b>Manufacturer</b>	ROOTS Regulators	2	(0.14)	710	(20.1)	1140	(32.3)	1900	(53.8)	2185	(61.9)	3135	(88.8)
<b>Type and model</b>	B38IM	3	(0.21)	855	(24.2)	1615	(45.7)	2470	(70.0)	2945	(83.4)	3800	(107.6)
<b>Inlet size</b>	1-1/2" NPT	5	(0.35)	1820	(51.5)	2185	(61.8)	3800	(107.6)	4180	(118.3)	5510	(156.0)
<b>Outlet size</b>	1-1/2" NPT	10	(0.69)	2570	(72.7)	3420	(96.8)	6080	(172.0)	6940	(196.5)	8550	(242.0)
<b>Position</b>	11	20	(1.38)	4085	(115.6)	5985	(169.5)	9500	(269.0)	10925	(309.3)	13300	(376.6)
<b>Loading ring setting</b>	-0°	30	(2.07)	5795	(164.0)	8075	(228.6)	12825	(363.0)	14250	(403.5)	17280	(489.3)
		40	(2.76)	7125	(201.7)	9975	(282.4)	15675	(443.8)	17100	(484.2)	18675	(528.8)
		50	(3.45)	8550	(242.0)	11875	(336.0)	17575	(497.6)	19000	(538.0)	20000	(566.0)
		60	(4.14)	9785	(277.0)	13585	(384.6)	19000	(538.0)	20000	(566.0)	20000	(566.0)
		70	(4.83)	11080	(313.7)	15250	(431.8)	20000	(566.0)	20000	(566.0)	20000	(566.0)
		80	(5.52)	12560	(355.6)	16640	(471.0)	20000	(566.0)	20000	(566.0)	20000	(566.0)
		90	(6.21)	13460	(381.0)	18650	(528.0)	20000	(566.0)	20000	(566.0)	20000	(566.0)
		100	(6.90)	14915	(422.3)	19000	(538.0)	20000	(566.0)	20000	(566.0)	20000	(566.0)
		125	(8.63)	18390	(520.7)	20000	(566.0)	20000	(566.0)	20000	(566.0)		
		Inlet Effect A (PSIG)		0.01		0.01		0.02		0.02		0.04	
		Lock Up B (PSIG)		0.02		0.05		0.06		0.09		0.12	

Notes:

A Change in outlet pressure for 10 PSIG inlet pressure change.

B. Outlet pressure increase required for lockup.

\*Individual regulator performance may vary from data shown.

 Do not operate orifice in shaded inlet pressure area.

# B38 IM PERFORMANCE CURVES

## 1 PSIG Set Point

<b>Type and model</b>	B38IMR
Inlet size	2" NPT
Outlet size	2" NPT
Orifice size	3/8"
Spring	Blue/white

All test results are reported at a base of 14.7 PSIA at 60° F and with 0.6 S.G. gas.

**B38 IM REGULATOR PERFORMANCE  
1 PSIG SET POINT**

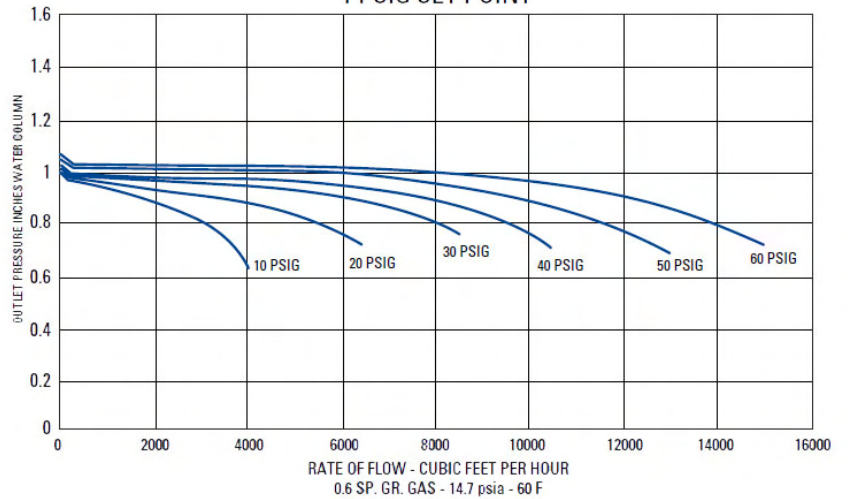

## RELIEF CURVES

### 1 PSIG Set Point

Inlet size	2" NPT
Outlet size	2" NPT
Vent size	2-1/2" NPT

All test results are reported at a base of 14.7 PSIG at 60° F and with 0.6 S.G. gas.

**B38 IM RELIEF CURVES - BLOCKED PER ORIFICE  
1 PSIG SET POINT**

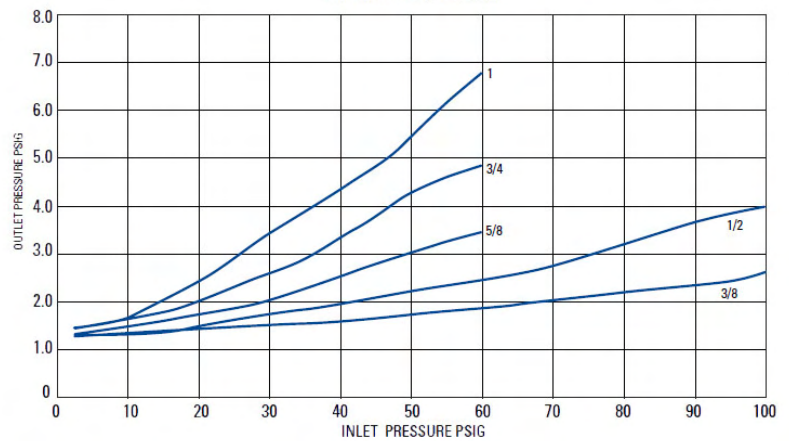

# B38 SERIES COMMERCIAL REGULATOR, MODELS IMN, IMR, AND IMRV

2 PSIG (138 mbar) Capacity Table (1% Absolute Droop\*), 2" NPT Inlet/Outlet

Capacities in SCFH (m 3/hr) of 0.6 S.G. gas; base conditions of 14.7 PSIA and 60° F.

Typical Capacity Info.		Inlet Pressure		Orifice Size									
		PSIG	Bar	3/8"		1/2"		5/8"		3/4"		1"	
<b>Manufacturer</b>	ROOTS Regulators	3	(0.21)	400	(11.2)	750	(21.0)	800	(22.4)	1000	(28.0)	1600	(44.8)
<b>Type and model</b>	B38IM	5	(0.35)	900	(25.2)	1150	(32.2)	1400	(39.2)	1750	(49.0)	3000	(84.0)
<b>Inlet size</b>	2" NPT	10	(0.69)	1750	(49.0)	2300	(64.4)	2500	(70.0)	3500	(98.0)	5000	(140.0)
<b>Outlet size</b>	2" NPT	15	(1.03)	2300	(64.4)	2700	(76.4)	3300	(92.4)	5200	(145.6)	7400	(207.2)
<b>Position</b>	11	20	(1.38)	2500	(70.0)	3600	(100.8)	6000	(168.0)	7500	(210.0)	8500	(238.0)
<b>Loading ring setting</b>	-0°	25	(1.72)	3600	(100.8)	5400	(151.2)	7100	(201.0)	9500	(266.0)	13300	(372.4)
		30	(2.07)	4600	(130.2)	5700	(159.6)	8300	(232.4)	10000	(280.0)	16400	(459.2)
		40	(2.76)	5000	(140.0)	7000	(196.0)	11500	(322.0)	14000	(392.0)	17300	(489.8)
		50	(3.45)	6300	(176.4)	8500	(238.0)	13000	(364.0)	16500	(462.0)	18400	(521.0)
		60	(4.14)	7400	(207.2)	14000	(392.0)	16300	(456.4)	20000	(566.0)	20000	(566.0)
		70	(4.83)	8560	(239.7)	16600	(470.0)	17500	(495.5)	20000	(566.0)	20000	(566.0)
		75	(5.17)	10600	(296.8)	17800	(504.0)	18700	(529.5)	20000	(566.0)	20000	(566.0)
		80	(5.52)	12100	(342.6)	18700	(529.5)	19300	(546.5)	20000	(566.0)	20000	(566.0)
		90	(6.21)	13500	(378.0)	20000	(566.0)	20000	(566.0)	20000	(566.0)	20000	(566.0)
		95	(6.55)	14100	(394.8)	20000	(566.0)	20000	(566.0)	20000	(566.0)	20000	(566.0)
		100	(6.90)	16200	(458.7)	20000	(566.0)	20000	(566.0)	20000	(566.0)	20000	(566.0)
		125	(8.63)	18000	(509.7)	20000	(566.0)	20000	(566.0)	20000	(566.0)		

Inlet Effect A (PSIG)	0.01	0.01	0.02	0.02	0.05
Lock Up B (PSIG)	0.03	0.05	0.07	0.10	0.14

Notes:

A. Change in outlet pressure for 10 PSIG inlet pressure change.

B. Outlet pressure increase required for lockup.

\*Individual regulator performance may vary from data shown.

 Do not operate orifice in shaded inlet pressure area.

# B38 SERIES COMMERCIAL REGULATOR, MODELS IMN, IMR, AND IMRV

## 2 PSIG (138 mbar) Capacity Table (2% Absolute Droop\*), 2" NPT Inlet/Outlet

Capacities in SCFH (m<sup>3</sup>/hr) of 0.6 S.G. gas; base conditions of 14.7 PSIA and 60°F.

Typical Capacity Info.		Inlet Pressure		Orifice Size									
		PSIG	Bar	3/8"		1/2"		5/8"		3/4"		1"	
<b>Manufacturer</b>	ROOTS Regulators	3	(0.21)	700	(19.6)	1150	(32.2)	1500	(42.0)	1900	(53.2)	2700	(75.6)
<b>Type and model</b>	B38IM	5	(0.35)	1300	(36.4)	2000	(56.0)	2500	(70.0)	3300	(92.4)	4500	(126.0)
<b>Inlet size</b>	2" NPT	10	(0.69)	2500	(70.0)	3600	(100.8)	4500	(126.0)	6000	(168.0)	7300	(204.4)
<b>Outlet size</b>	2" NPT	15	(1.03)	3300	(92.4)	5000	(140.0)	6400	(179.2)	8000	(224.0)	10500	(294.0)
<b>Position</b>	11	20	(1.38)	3800	(106.4)	5300	(148.4)	8500	(238.0)	10000	(280.0)	12000	(336.0)
<b>Loading ring setting</b>	-0°	25	(1.72)	5000	(140.0)	7000	(196.0)	9500	(266.0)	12500	(350.0)	16000	(448.0)
		30	(2.07)	5300	(148.4)	7500	(210.0)	11500	(322.0)	13200	(396.6)	19300	(540.4)
		40	(2.76)	7000	(196.0)	9200	(257.6)	13500	(382.2)	16000	(448.0)	20000	(566.0)
		50	(3.45)	8300	(232.4)	11200	(313.6)	15100	(427.5)	18400	(521.4)	20000	(566.0)
		60	(4.14)	9400	(263.2)	15000	(420.0)	18200	(515.3)	20000	(566.0)	20000	(566.0)
		70	(4.83)	10200	(288.8)	18200	(515.3)	20000	(566.0)	20000	(566.0)	20000	(566.0)
		75	(5.17)	11200	(313.6)	19600	(555.0)	20000	(566.0)	20000	(566.0)	20000	(566.0)
		80	(5.52)	12430	(348.0)	20000	(566.0)	20000	(566.0)	20000	(566.0)	20000	(566.0)
		90	(6.21)	14160	(396.5)	20000	(566.0)	20000	(566.0)	20000	(566.0)	20000	(566.0)
		95	(6.55)	15800	(447.4)	20000	(566.0)	20000	(566.0)	20000	(566.0)	20000	(566.0)
		100	(6.90)	17000	(476.0)	20000	(566.0)	20000	(566.0)	20000	(566.0)	20000	(566.0)
		125	(8.63)	19000	(538.0)	20000	(566.0)	20000	(566.0)	20000	(566.0)		

Inlet Effect A (PSIG)	0.01	0.01	0.02	0.02	0.05
Lock Up B (PSIG)	0.03	0.05	0.07	0.10	0.14

Notes:

A. Change in outlet pressure for 10 PSIG inlet pressure change.

B. Outlet pressure increase required for lockup.

\*Individual regulator performance may vary from data shown.



Do not operate orifice in shaded inlet pressure area.

# B38 SERIES COMMERCIAL REGULATOR, MODELS IMN, IMR, AND IMRV

2 PSIG (138 mbar) Capacity Table (1% Absolute Droop\*), 1-1/2" NPT Inlet/Outlet

Capacities in SCFH (m<sup>3</sup>/hr) of 0.6 S.G. gas; base conditions of 14.7 PSIA and 60° F.

Typical Capacity Info.		Inlet Pressure		Orifice Size									
		PSIG	Bar	3/8"		1/2"		5/8"		3/4"		1"	
<b>Manufacturer</b>	ROOTS Regulators	3	(0.21)	380	(10.7)	715	(20.2)	760	(21.5)	950	(26.9)	1520	(43.0)
<b>Type and model</b>	B38IM	5	(0.35)	855	(24.2)	1100	(31.0)	1330	(37.6)	1665	(47.1)	2850	(80.7)
<b>Inlet size</b>	1-1/2" NPT	10	(0.69)	1665	(47.1)	2185	(61.8)	2375	(67.2)	3325	(94.1)	4750	(134.5)
<b>Outlet size</b>	1-1/2" NPT	15	(1.03)	2185	(61.8)	2565	(72.6)	3135	(88.7)	4940	(140.0)	7030	(199.0)
<b>Position</b>	11	20	(1.38)	2375	(67.2)	3420	(96.8)	5700	(161.4)	7125	(201.7)	8025	(227.2)
<b>Loading ring setting</b>	-0°	25	(1.72)	3420	(96.8)	5130	(145.2)	6745	(191.0)	9025	(269.0)	12640	(357.9)
		30	(2.07)	4370	(134.5)	5415	(153.3)	7885	(223.2)	9500	(269.0)	15580	(441.1)
		40	(2.76)	4750	(134.5)	6650	(188.3)	10925	(309.3)	13300	(376.6)	16432	(465.3)
		50	(3.45)	5985	(169.4)	8075	(228.6)	12350	(349.7)	15675	(443.8)	17480	(494.9)
		60	(4.14)	7030	(199.0)	13300	(376.6)	15485	(438.4)	19000	(538.0)	20000	(566.0)
		70	(4.83)	8135	(230.3)	15570	(446.5)	16625	(470.7)	20000	(566.0)	20000	(566.0)
		75	(5.17)	10070	(285.1)	16910	(478.8)	17765	(503.0)	20000	(566.0)	20000	(566.0)
		80	(5.52)	11495	(325.5)	17765	(503.0)	18335	(519.1)	20000	(566.0)	20000	(566.0)
		90	(6.21)	12825	(363.1)	19000	(538.0)	20000	(566.0)	20000	(566.0)	20000	(566.0)
		95	(6.55)	13395	(379.3)	20000	(566.0)	20000	(566.0)	20000	(566.0)	20000	(566.0)
		100	(6.90)	15390	(435.7)	20000	(566.0)	20000	(566.0)	20000	(566.0)	20000	(566.0)
		125	(8.63)	18050	(511.1)	20000	(566.0)	20000	(566.0)	20000	(566.0)		

Inlet Effect A (PSIG)	0.01	0.01	0.02	0.02	0.05
Lock Up B (PSIG)	0.03	0.05	0.07	0.10	0.14

Notes:

A. Change in outlet pressure for 10 PSIG inlet pressure change.

B. Outlet pressure increase required for lockup.

\*Individual regulator performance may vary from data shown.



Do not operate orifice in shaded inlet pressure area.

# B38 SERIES COMMERCIAL REGULATOR, MODELS IMN, IMR, AND IMRV

## 2 PSIG (138 mbar) Capacity Table (2% Absolute Droop\*), 1-1/2" NPT Inlet/Outlet

Capacities in SCFH (m<sup>3</sup>/hr) of 0.6 S.G. gas; base conditions of 14.7 PSIA and 60° F.

Typical Capacity Info.		Inlet Pressure		Orifice Size									
		PSIG	Bar	3/8"		1/2"		5/8"		3/4"		1"	
<b>Manufacturer</b>	ROOTS Regulators	3	(0.21)	665	(18.8)	1100	(31.1)	1425	(40.3)	1805	(51.1)	2565	(72.6)
<b>Type and model</b>	B38IM	5	(0.35)	1235	(34.9)	1900	(53.8)	2375	(67.2)	3135	(88.7)	4275	(121.0)
<b>Inlet size</b>	1-1/2" NPT	10	(0.69)	2375	(67.2)	3420	(96.8)	4275	(121.0)	5700	(161.4)	6935	(196.3)
<b>Outlet size</b>	1-1/2" NPT	15	(1.03)	3135	(88.7)	4750	(134.5)	6080	(172.1)	7600	(215.2)	9975	(282.4)
<b>Position</b>	11	20	(1.38)	3610	(102.2)	5035	(142.5)	8075	(228.6)	9500	(269.0)	11400	(322.8)
<b>Loading ring setting</b>	-0°	25	(1.72)	4750	(140.0)	7000	(196.0)	9500	(266.0)	12500	(350.0)	16000	(448.0)
		30	(2.07)	5035	(142.5)	7125	(201.7)	10925	(309.3)	12540	(355.0)	18435	(522.0)
		40	(2.76)	6650	(188.3)	8740	(247.4)	12825	(363.1)	15200	(430.4)	19000	(538.0)
		50	(3.45)	7885	(223.2)	10640	(301.2)	14345	(406.2)	17480	(495.0)	20000	(566.0)
		60	(4.14)	8930	(252.8)	14250	(403.5)	17290	(489.5)	19000	(538.0)	20000	(566.0)
		70	(4.83)	9640	(272.9)	17290	(489.5)	19000	(538.0)	20000	(566.0)	20000	(566.0)
		75	(5.17)	10640	(301.2)	18620	(527.2)	20000	(566.0)	20000	(566.0)	20000	(566.0)
		80	(5.52)	11810	(334.4)	20000	(566.0)	20000	(566.0)	20000	(566.0)	20000	(566.0)
		90	(6.21)	13445	(381.0)	20000	(566.0)	20000	(566.0)	20000	(566.0)	20000	(566.0)
		95	(6.55)	15010	(425.0)	20000	(566.0)	20000	(566.0)	20000	(566.0)	20000	(566.0)
		100	(6.90)	16150	(457.3)	20000	(566.0)	20000	(566.0)	20000	(566.0)	20000	(566.0)
		125	(8.63)	18050	(511.1)	20000	(566.0)	20000	(566.0)	20000	(566.0)		

Inlet Effect A (PSIG)	0.01	0.01	0.02	0.02	0.05
Lock Up B (PSIG)	0.03	0.05	0.07	0.10	0.14

Notes:

A. Change in outlet pressure for 10 PSIG inlet pressure change.

B. Outlet pressure increase required for lockup.

\*Individual regulator performance may vary from data shown.

 Do not operate orifice in shaded inlet pressure area.

# B38 PERFORMANCE CURVES

## 2 PSIG Set Point

<b>Type and model</b>	B38IMR
Inlet size	2" NPT
Outlet size	2" NPT
Orifice size	3/8"
Spring	Silver/red

All test results are reported at a base of 14.7 PSIG at 60° F and with 0.6 S.G. gas.

B38 IM REGULATOR PERFORMANCE  
2 PSIG SET POINT

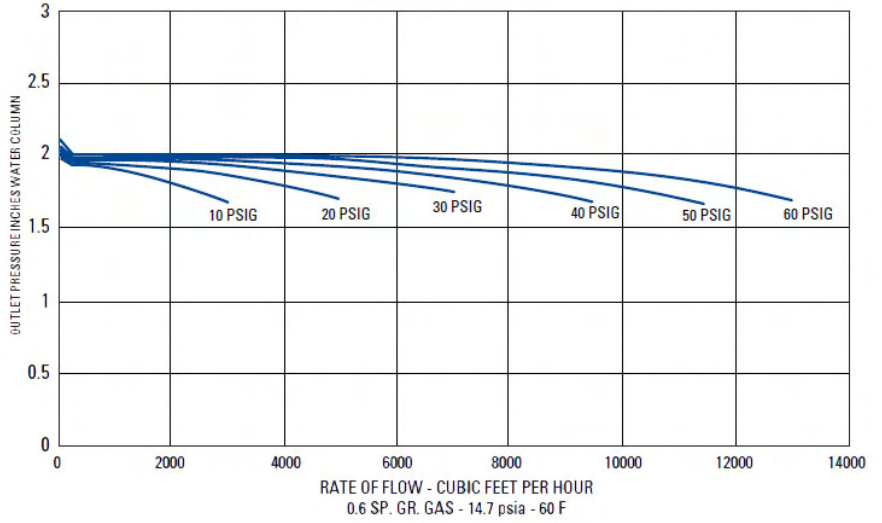

# RELIEF CURVES

## 2 PSIG Set Point

Inlet size	2" NPT
Outlet size	2" NPT
Vent size	2-1/2" NPT

All test results are reported at a base of 14.7 PSIG at 60° F and with 0.6 S.G. gas.

B38 IM RELIEF CURVES - BLOCKED PER ORIFICE  
2 PSIG SET POINT

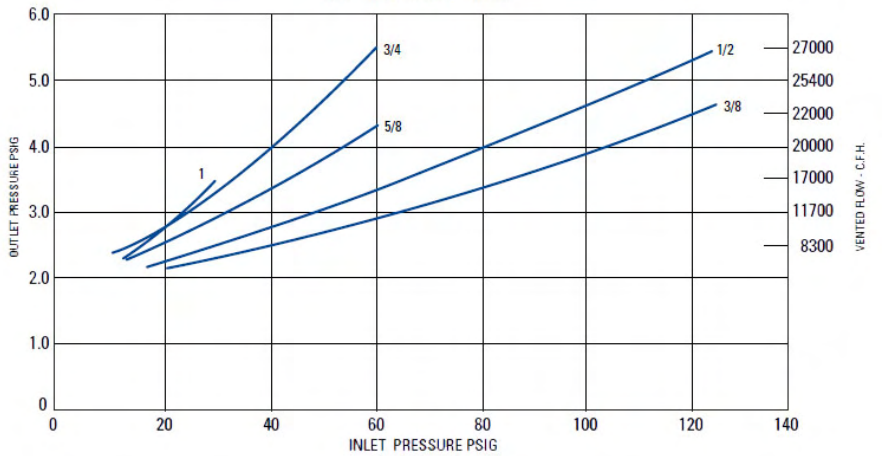



# B38 SERIES COMMERCIAL REGULATOR, MODELS IMN, IMR, AND IMRV

5 PSIG (345 mbar) Capacity Table (1% Absolute Droop\*), 2" NPT Inlet/Outlet

Capacities in SCFH (m 3/hr) of 0.6 S.G. gas; base conditions of 14.7 PSIA and 60° F.

Typical Capacity Info.		Inlet Pressure		Orifice Size									
		PSIG	Bar	3/8"		1/2"		5/8"		3/4"		1"	
<b>Manufacturer</b>	ROOTS Regulators	10	(0.69)	750	(21.0)	1000	(28.0)	1100	(31.1)	1200	(33.9)	1600	(44.8)
		15	(1.03)	1000	(28.0)	1150	(32.2)	1700	(47.6)	1800	(50.4)	2000	(56.0)
<b>Type and model</b>	B38IM	20	(1.38)	1100	(31.1)	1300	(36.4)	2000	(56.0)	2300	(64.4)	2500	(70.0)
<b>Inlet size</b>	2" NPT	25	(1.72)	1200	(33.6)	1700	(47.6)	2350	(65.8)	2500	(70.0)	2850	(79.8)
<b>Outlet size</b>	2" NPT	30	(2.07)	1500	(42.0)	1900	(53.2)	2500	(70.0)	3000	(84.0)	3750	(105.0)
<b>Position</b>	11	40	(2.76)	1700	(47.6)	2300	(64.4)	3200	(89.6)	4000	(112.0)	4350	(123.1)
<b>Loading ring setting</b>	-0°	50	(3.45)	2000	(56.0)	2800	(78.4)	6000	(168.0)	6500	(182.0)	7525	(210.2)
		60	(4.14)	3000	(84.0)	3050	(85.4)	7000	(196.0)	8000	(224.0)	9700	(274.6)
		70	(4.83)	3103	(86.9)	4066	(113.9)	8100	(229.3)	9250	(261.9)	10325	(292.3)
		75	(5.17)	3420	(96.8)	4200	(117.6)	9430	(267.0)	10120	(286.5)	11740	(332.4)
		80	(5.52)	3616	(101.3)	5650	(158.2)	9920	(280.9)	11525	(326.3)	13020	(368.6)
		90	(6.21)	4484	(125.6)	6750	(189.0)	11010	(311.7)	12600	(356.7)	14800	(419.0)
		95	(6.55)	4500	(127.4)	7552	(211.5)	12420	(351.6)	1375	(392.8)	16030	(453.9)
		100	(6.90)	4700	(131.6)	7650	(216.6)	14000	(396.4)	15100	(427.5)	17800	(504.0)
		125	(8.63)	7500	(210.0)	11300	(316.4)	16275	(460.8)	18000	(509.7)		

Inlet Effect A (PSIG)	0.01	0.01	0.02	0.03	0.07
Lock Up B (PSIG)	0.08	0.11	0.11	0.11	0.18

Notes:

A. Change in outlet pressure for 10 PSIG inlet pressure change.

B. Outlet pressure increase required for lockup.

\*Individual regulator performance may vary from data shown.



Do not operate orifice in shaded inlet pressure area.

# B38 SERIES COMMERCIAL REGULATOR, MODELS IMN, IMR, AND IMRV

## 5 PSIG (345 mbar) Capacity Table (2% Absolute Droop\*), 2" NPT Inlet/Outlet

Capacities in SCFH (m<sup>3</sup>/hr) of 0.6 S.G. gas; base conditions of 14.7 PSIA and 60° F.

Typical Capacity Info.		Inlet Pressure		Orifice Size									
		PSIG	Bar	3/8"		1/2"		5/8"		3/4"		1"	
<b>Manufacturer</b>	ROOTS Regulators	10	(0.69)	1100	(30.8)	1200	(33.6)	1800	(50.4)	2000	(56.6)	2650	(74.2)
		15	(1.03)	1600	(44.8)	1850	(51.8)	2700	(75.6)	2850	(79.8)	3500	(98.0)
<b>Type and model</b>	B38IM	20	(1.38)	1850	(52.3)	2100	(58.8)	3400	(95.2)	3500	(98.0)	4000	(112.0)
<b>Inlet size</b>	2" NPT	25	(1.72)	2100	(58.8)	2550	(71.4)	4000	(112.0)	4250	(119.0)	5500	(155.7)
<b>Outlet size</b>	2" NPT	30	(2.07)	2300	(64.4)	2600	(72.8)	4300	(120.4)	4500	(126.0)	7000	(196.0)
<b>Position</b>	11	40	(2.76)	2700	(75.6)	3000	(84.0)	4500	(126.0)	5200	(145.6)	8200	(232.1)
<b>Loading ring setting</b>	-0°	50	(3.45)	3850	(107.8)	5800	(162.4)	8000	(224.0)	9000	(252.0)	10400	(294.4)
		60	(4.14)	4100	(114.8)	6250	(175.0)	10500	(294.0)	11000	(308.0)	12200	(354.4)
		70	(4.83)	5000	(140.0)	7800	(218.4)	11100	(314.3)	12500	(353.9)	13600	(385.1)
		75	(5.17)	5500	(154.0)	8400	(235.2)	12650	(358.2)	13750	(389.3)	14850	(420.5)
		80	(5.52)	6000	(168.0)	8800	(246.4)	13905	(393.7)	15000	(424.7)	16350	(462.9)
		90	(6.21)	7500	(210.0)	10000	(280.0)	14990	(424.4)	16800	(476.7)	17800	(504.0)
		95	(6.55)	7900	(221.2)	11600	(324.8)	16100	(455.9)	17950	(508.2)	19000	(538.0)
		100	(6.90)	8300	(232.4)	12200	(341.6)	17650	(499.7)	19100	(540.8)	20000	(566.0)
		125	(8.63)	10500	(294.0)	15000	(420.0)	18800	(532.3)	20000	(566.0)		

Inlet Effect A (PSIG)	0.01	0.01	0.02	0.03	0.07
Lock Up B (PSIG)	0.08	0.11	0.11	0.11	0.18

Notes:

A. Change in outlet pressure for 10 PSIG inlet pressure change.

B. Outlet pressure increase required for lockup.

\*Individual regulator performance may vary from data shown.

 Do not operate orifice in shaded inlet pressure area.

# B38 SERIES COMMERCIAL REGULATOR, MODELS IMN, IMR, AND IMRV

5 PSIG (345 mbar) Capacity Table (1% Absolute Droop\*), 1-1/2" NPT Inlet/Outlet

Capacities in SCFH (m3/hr) of 0.6 S.G. gas; base conditions of 14.7 PSIA and 60° F.

Typical Capacity Info.		Inlet Pressure		Orifice Size									
		PSIG	Bar	3/8"		1/2"		5/8"		3/4"		1"	
<b>Manufacturer</b>	ROOTS	10	(0.69)	720	(20.3)	975	(27.6)	1045	(29.5)	1140	(32.2)	1520	(43.0)
	Regulators	15	(1.03)	950	(26.9)	1100	(31.1)	1615	(45.7)	1710	(48.4)	1900	(53.8)
<b>Type and model</b>	B38IM	20	(1.38)	1045	(29.5)	1235	(34.9)	1900	(53.8)	2185	(61.8)	2375	(67.2)
<b>Inlet size</b>	1-1/2" NPT	25	(1.72)	1090	(30.8)	1615	(45.7)	2235	(63.2)	2375	(67.2)	2710	(76.7)
<b>Outlet size</b>	1-1/2" NPT	30	(2.07)	1375	(38.9)	1805	(51.1)	2375	(67.2)	2850	(80.7)	3560	(100.8)
<b>Position</b>	11	40	(2.76)	1615	(45.7)	2185	(61.8)	3040	(86.0)	3800	(107.6)	4135	(117.0)
<b>Loading ring setting</b>	-0°	50	(3.45)	1900	(53.8)	2660	(75.3)	5700	(161.4)	6175	(174.8)	7055	(199.7)
		60	(4.14)	2850	(80.7)	2900	(82.1)	6650	(188.3)	7600	(215.2)	9220	(261.0)
		70	(4.83)	2945	(83.3)	3866	(109.4)	7695	(217.8)	8790	(248.9)	9810	(277.7)
		75	(5.17)	3250	(92.0)	3990	(112.9)	8960	(253.7)	9620	(272.4)	11160	(316.0)
		80	(5.52)	3400	(96.2)	5370	(152.0)	9430	(267.0)	10950	(310.0)	12370	(350.2)
		90	(6.21)	4260	(120.6)	6365	(180.2)	10360	(293.3)	11970	(338.9)	14060	(398.1)
		95	(6.55)	4275	(121.0)	7170	(203.0)	11800	(334.1)	13185	(373.3)	15230	(431.2)
		100	(6.90)	4465	(126.4)	7270	(205.8)	13300	(376.6)	14350	(406.3)	16910	(478.8)
		125	(8.63)	7125	(201.7)	10735	(303.9)	15465	(437.9)	17100	(484.2)		

Inlet Effect A (PSIG)	0.01	0.01	0.02	0.03	0.07
Lock Up B (PSIG)	0.08	0.11	0.11	0.11	0.18

Notes:

A. Change in outlet pressure for 10 PSIG inlet pressure change.

B. Outlet pressure increase required for lockup.

\*Individual regulator performance may vary from data shown.



Do not operate orifice in shaded inlet pressure area.

# B38 SERIES COMMERCIAL REGULATOR, MODELS IMN, IMR, AND IMRV

## 5 PSIG (345 mbar) Capacity Table (2% Absolute Droop\*), 1-1/2" NPT Inlet/Outlet

Capacities in SCFH (m<sup>3</sup>/hr) of 0.6 S.G. gas; base conditions of 14.7 PSIA and 60° F

Typical Capacity Info.		Inlet Pressure		Orifice Size									
		PSIG	Bar	3/8"		1/2"		5/8"		3/4"		1"	
<b>Manufacturer</b>	ROOTS Regulators	10	(0.69)	1045	(29.5)	1140	(32.2)	1710	(48.4)	1900	(53.8)	2520	(71.3)
		15	(1.03)	1520	(43.0)	1760	(49.8)	2565	(72.6)	2710	(76.7)	3325	(94.1)
<b>Type and model</b>	B38IM	20	(1.38)	1760	(49.8)	1995	(56.4)	3230	(91.4)	3325	(94.1)	3800	(107.6)
Inlet size	1-1/2" NPT	25	(1.72)	1995	(56.4)	2425	(68.6)	3800	(107.6)	4040	(114.4)	5225	(147.9)
Outlet size	1-1/2" NPT	30	(2.07)	2185	(61.8)	2470	(69.9)	4085	(115.6)	4275	(121.0)	6650	(188.3)
<b>Position</b>	11	40	(2.76)	2565	(72.6)	2850	(80.7)	4275	(121.0)	4940	(139.8)	7790	(220.5)
<b>Loading ring setting</b>	-0°	50	(3.45)	3660	(103.6)	5510	(156.0)	7600	(215.2)	8550	(242.1)	9880	(279.7)
		60	(4.14)	3895	(110.2)	5940	(168.2)	9975	(282.4)	10450	(295.9)	11590	(328.1)
		70	(4.83)	4750	(134.5)	7410	(209.8)	10945	(309.9)	11875	(336.2)	12920	(365.8)
		75	(5.17)	5225	(147.9)	7980	(225.9)	12020	(340.3)	13150	(372.3)	14110	(399.5)
		80	(5.52)	5700	(161.4)	8360	(236.7)	13210	(374.0)	14250	(403.5)	15535	(439.9)
		90	(6.21)	7125	(201.7)	9500	(269.0)	14240	(403.2)	15960	(451.9)	16910	(478.8)
		95	(6.55)	7510	(212.6)	11020	(312.0)	15295	(433.1)	17055	(482.9)	18050	(511.1)
		100	(6.90)	7885	(232.4)	11590	(328.1)	16770	(474.8)	18150	(513.9)	20000	(566.0)
		125	(8.63)	9975	(282.4)	14250	(403.5)	17860	(505.7)	19000	(538.0)		

Inlet Effect A (PSIG)	0.01	0.01	0.02	0.03	0.07
Lock Up B (PSIG)	0.08	0.11	0.11	0.11	0.18

Notes:

A. Change in outlet pressure for 10 PSIG inlet pressure change.

B. Outlet pressure increase required for lockup.

\*Individual regulator performance may vary from data shown.

 Do not operate orifice in shaded inlet pressure area.

# B38 PERFORMANCE CURVES

## 5 PSIG Set Point

<b>Type and model</b>	B38IMR
Inlet size	2" NPT
Outlet size	2" NPT
Orifice size	3/8"
Spring	Red nested

All test results are reported at a base of 14.7 PSIG at 60° F and with 0.6 S.G. gas.

B38 IM REGULATOR PERFORMANCE  
5 PSIG SET POINT

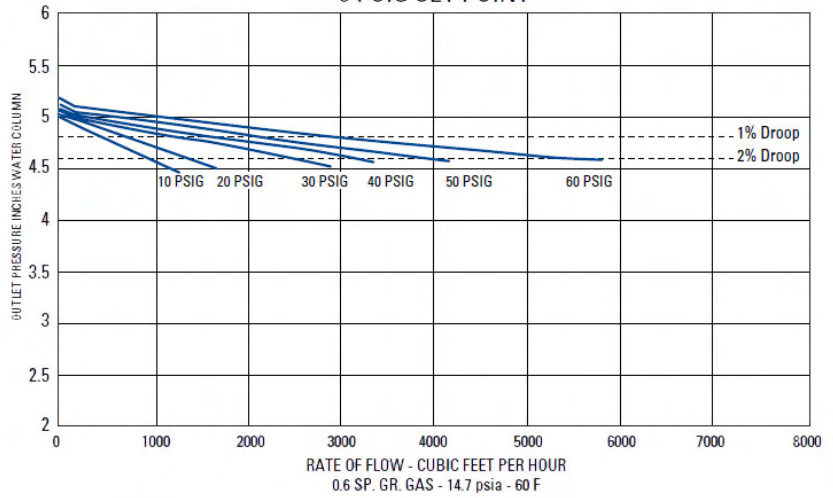

# RELIEF CURVES

## 5 PSIG Set Point

Inlet size	2" NPT
Outlet size	2" NPT
Vent size	2-1/2" NPT

All test results are reported at a base of 14.7 PSIG at 60° F and with 0.6 S.G. gas.

B38 IM RELIEF CURVES - BLOCKED PER ORIFICE  
5 PSIG SET POINT

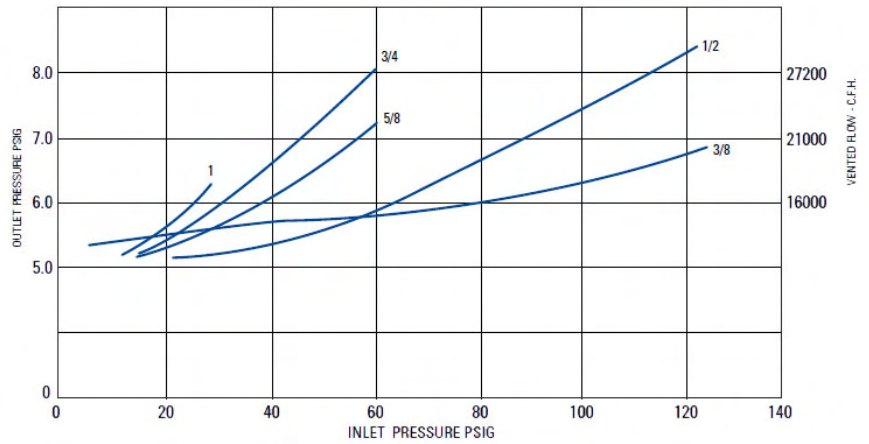

# ASSEMBLY POSITIONS

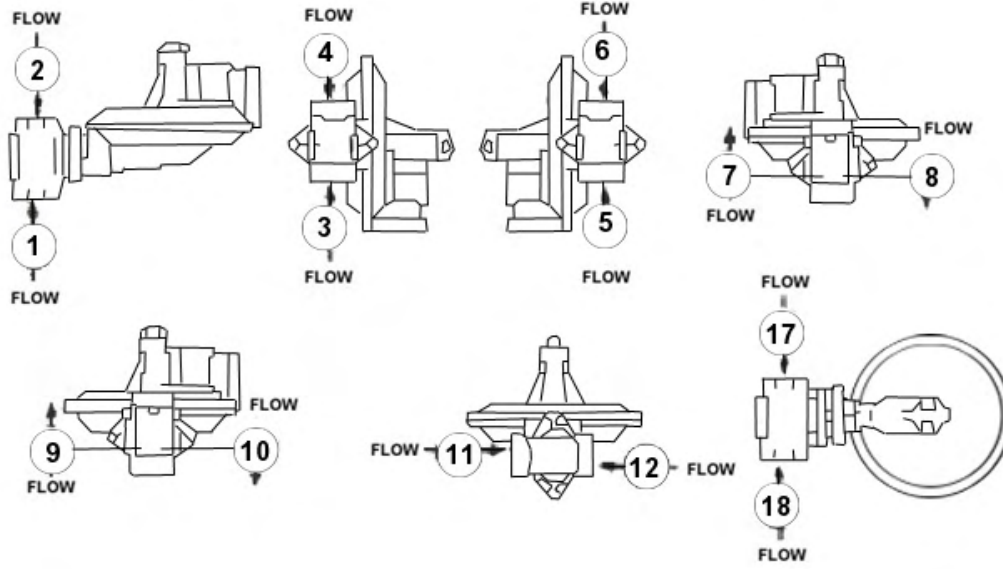

# B38 PARTS DIAGRAM

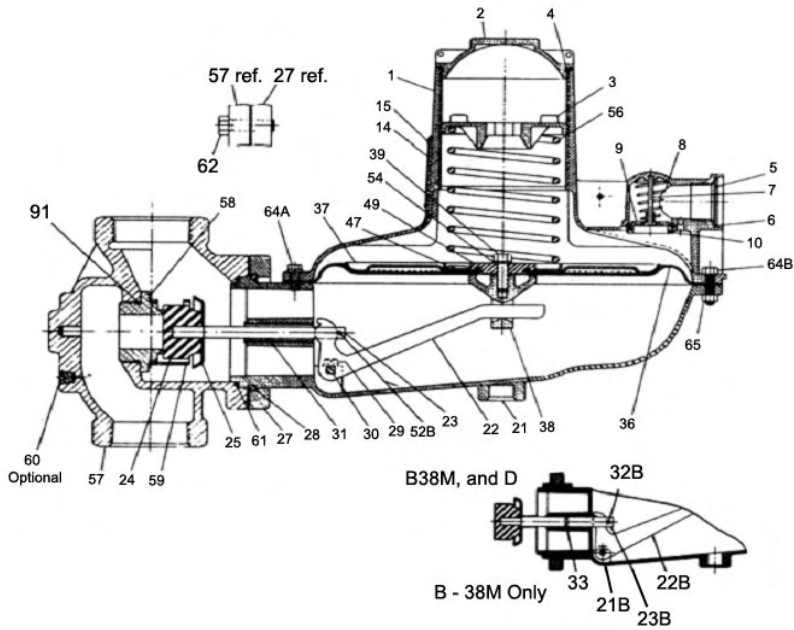

B38R

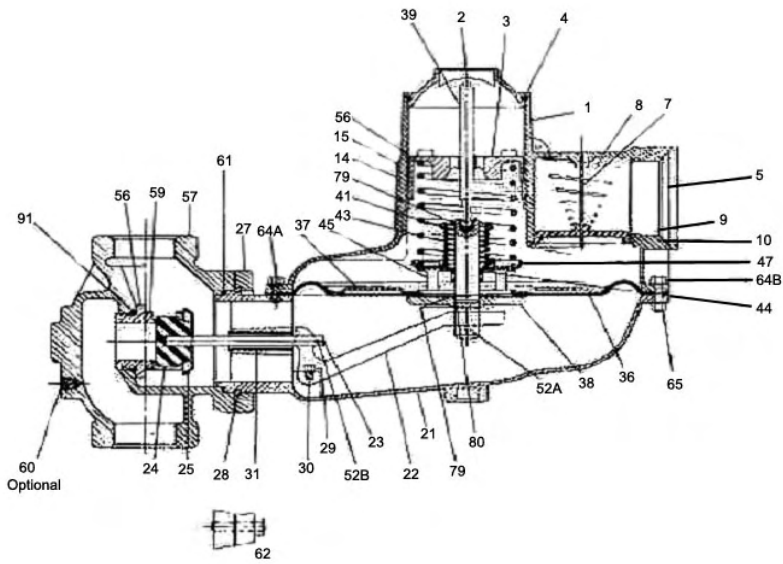

**B38 Parts List**

Item #	Part #	Quantity Required per Regulator Model						Description	
		RD	RM	D	M	R	N		
1	753404SU			1	1			1	Upper diaphragm case, vent -1" pipe
1A	753434SU	1	1					1	Upper diaphragm case, vent - 2-1/2" pipe (standard)
2	760083	1	1	1	1	1	1		Seal cap
3	760233			1	1			1	Adjustment screw
3A	760253	1	1					1	Seal cap gasket
4	765607	1	1	1	1	1	1		Adjustment screw
5	762933			1	1			1	Vent screen - 1" vent
5A	762941	1	1					1	Vent screen - 2-1/2" vent
6	75579102			1	1			1	Vent screen retainer ring - 1" vent
7	75483401			1	1			1	Vent valve disc pin - 1" vent.
7A	754801	1	1					1	Vent valve disc pin - 2-1/2" vent
8	Vent valve spring								
	762601			1	1			1	1" vent (standard)
	80000601	1	1						1 2-1/2" vent (standard)
9	765181			1	1			1	Vent valve disc - molded nylon - 1" vent
9A	765343	1	1					1	Vent valve disc - molded nylon - 2-1/2" vent
10	765685			1	1			1	Vent valve seat - 1" vent
10A	761651	1	1					1	Vent valve seat - 2-1/2" vent
14	769250	1	1	1	1	1	1		Regulator badge
15	755071	2	2	2	2	2	2		Badge drive screw
21									Lower diaphragm case
	715065							1	4:1 ratio- open throat
	715066	1	1	1	1				3.5:1 ratio - closed throat
22									Valve linkage lever - specify ratio
	761275							1	4:1 ratio
	761271	1	1	1	1				3.5:1 ratio
23	Valve stem								
	754191							1	3/8" square
	754193	1	1	1	1				17/32" diameter with O-ring groove
24	765211	1	1	1	1	1	1		Valve seat - Buna "N" - 80 Duro.
25	761731	1	1	1	1	1	1		Deflector
27	751933	1	1	1	1	1	1		Valve body retainer plate
28	755721	1	1	1	1	1	1		Retainer plate snap ring
29	755223	2	2	2	2	2	2		Linkage pin screw
30	754836	1	1	1	1	1	1		Valve linkage pin



Item #	Part #	Quantity Required per Regulator Model						Description
		RD	RM	D	M	R	N	
33	765505		1		1			Valve stem O-ring
36								Diaphragm
	766321	1	1			1		Relief
	766301			1	1		1	No relief
37								Upper diaphragm plate
	761091	1	1			1		R version
	76104101			1		1	1	N version
38	756075			1	1	1		Lower diaphragm plate with bead
	756081	1	1			1		Relief models only
39				1	1		1	Stop stem
	754385	1	1			1		Stop stem sub assembly-self aligning
	754381							Lower stop stem
	754383							Upper stop stem
	755739							Retaining ring (lower stem)
	765171							Disc (rubber)
41	761455	1	1			1		Relief spring guide
43	762423	1	1			1		Relief spring - brown/white
44	754941	1	1			1		Stop stem guide bushing
45	761671	1	1			1		Relief cap
47	761481	1	1			1		Adjustment spring guide for R-version
	761483			1	1		1	Adjustment spring guide for N-version
49	761081			1	1		1	Secondary diaphragm plate
52A	755001	1	1			1		Roll pin-stop stem
52B								Roll pin-valve stem
	755007	1		1				3/32" Diameter x 3/8" long
	755009	1	1	1	1			3/32" Diameter x 1/2" long
54	755851			1	1		1	Diaphragm plate washer - lock
56		1	1	1	1	1	1	Adjustment spring - specify
	762341							Orange
	762351							Brown
	762353							Green
	762321							Green/white
	762355							Black
	762365							Purple
	762357							Blue
	762358							Blue/white

Item #	Part #	Quantity Required per Regulator Model						Description
		RD	RM	D	M	R	N	
56	<i>continued</i>	1	1	1	1	1	1	Adjustment spring - specify
	762359							Silver
	762323							Silver/red
	762361							Yellow
	762671							Red (nested)
	762673							White (nested)
57		1	1	1	1	1	1	Valve body - see type & size:
	750823SU							1-1/2" x 1-1/2" NPT
	750826SU							1-1/2" x 1-1/2" NPT with 1/8" NPT inlet pipe plug
	750839SU							1-1/2" x 2" NPT
	750842SU							1-1/2" x 2" NPT with 1/8" NPT inlet pipe plug
	750854SU							2" x 2" NPT
	750857SU							2" x 2" NPT with 1/8" NPT inlet pipe plug
	750858SU							2" x 2 1/8" outlet tap
	750869SU							2" ASA 125 PSI flanged
	750872SU							2" ASA 125 PSI flanged with 1/8" NPT inlet pipe plug
	750874SU							2" with 1/4" outlet tap
	750885SU							3" ASA 125 PSI flanged
	750888SU							3" ASA 125 PSI flanged with 1/8" NPT inlet pipe plug
58		1	1	1	1	1	1	Orifice - straight- brass- 2-1/4" Hex
	758398							Orifice 1/4"
	758372							Orifice 1/4" x 3/8"
	758371							Orifice 3/20" x 3/8"
	758419							Orifice 3/8"
	758401							Orifice 1/2"
	758416							Orifice 5/8"
	758404							Orifice 3/4"
	758407							Orifice 1"
	758410							Orifice 1-1/4"
	758413							Orifice 1-3/8"
59	761771	1	1	1	1	1	1	Loading ring
60								Valve body pipe plug
	768433							1/8" NPT-steel
	768431							1/8" NPT - stainless steel
61	80001901	1	1	1	1	1	1	Valve body gasket
62	755391-001	2	2	2	2	2	2	Retainer plate screw-Hex head-3/8" - 16 x 1-5/16" long

Item #	Part #	Quantity Required per Regulator Model						Description
		RD	RM	D	M	R	N	
62A	755393-001	2	2	2	2	2	2	Retainer plate screw -Hex head - 3/8" -16 x 1-5/16" long - drilled head for wire seal
64	755311-001	12	12	12	12	12	12	Case screw-Hex head 1/4-20 x 1 high carb steel
65	755513-001	10	10	10	10	10	10	Case screw nut
79	755711	3	3			3		Stop stem retainer ring - external
80	765521	1	1			1		O-ring lower diaphragm
91	765525	1	1	1	1	1	1	Orifice O-ring
	770009	Replacement parts kit (models R, N, M, D)						
	770011	Replacement parts kit (models IMR, IMN)						
	Shaded items are contained in replacement parts kit.							

### B38 Sub Assemblies

Item #	Part #	Quantity Required per Regulator Model						Description
		RD	RM	D	M	R	N	
	710040			1	1		1	Upper diaphragm case 1" vent, sub assembly
	710045	1	1			1		Upper diaphragm case 2-1/2" vent, sub assembly
						1	1	Lower diaphragm case sub assembly
	715030							4:1 ratio - open throat
								Lower diaphragm case sub assembly
								3.5:1 ratio - closed throat
	715031		1		1			With valve stem O-ring
	715064	1		1				Without valve stem O-ring
	720029							Diaphragm sub assembly - no relief
	720033							Diaphragm sub assembly - relief

### Special Parts

Part No.	Description
799027	Orifice wrench machined
799055	Adjustment wrench
80002002	Seal wire no lead 24

### Torque Specifications

100 in. lbs	Retainer plate screws
600 in. lbs	Orifice
300 in. lbs	Orifice (IM & SO)
30 in. lbs	Margin screws (64A)
50 in. lbs	Margin screws (64B)

### Internal Monitor Orifice Cartridge Assembly Schematic

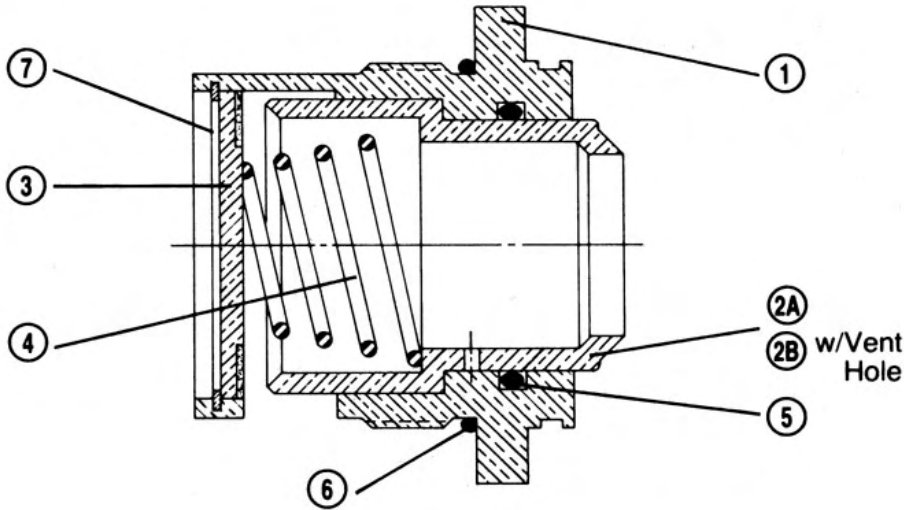

#### 1" Orifice Assembly

Item No.	Description	Part No.
1	Stationary orifice	758301
2A	1" Sliding orifice	758311
2B	1" Sliding orifice with vent hole	758314
3	Orifice plate	759023
4	Cut-off spring (black)	762685
5	O-ring	765523
6	O-ring	765525
7	Retaining ring	755737

#### 3/8" & 1/2" Orifice Assemblies (Interchangeable)

1	Stationary orifice	758307
2A	3/8" Sliding orifice	758357
2B	3/8" Sliding orifice with vent hole	758360
2A	1/2" Sliding orifice	758351
2B	1/2" Sliding orifice with vent hole	758354
3	Orifice plate	759025
4	Cut-off spring (red)	762683
5	O-ring	765531
6	O-ring	765525
7	Retaining ring	755737

<b>5/8" &amp; 3/4" Orifice Assemblies (Interchangeable)</b>		
1	Stationary orifice	758304
2A	5/8" Sliding orifice	758327
2B	5/8" Sliding orifice with vent hole	758330
2A	3/4" Sliding orifice	758321
2B	3/4" Sliding orifice with vent hole	758324
3	Orifice plate	759023
4	Cut-off spring (blue)	762681
5	O-ring	765533
6	O-ring	765525
7	Retaining ring	755737
<b>Complete Assembly Part Numbers</b>		
	1" Diameter	759031
	3/4" Diameter	759038
	5/8" Diameter	759035
	1/2" Diameter	759045
	3/8" Diameter	759041
	1" Diameter with vent hole	759033
	3/4" Diameter with vent hole	759039
	5/8" Diameter with vent hole	759037
	1/2" Diameter with vent hole	759047
	3/8" Diameter with vent hole	759043

## VENT LINES FOR REGULATORS

When constructing vent lines to be attached to regulators installed indoors, follow a few basic rules:

- Never use pipe sizes smaller than the vent size; smaller pipe sizes restrict the gas flow. If a long gas run must be used, ROOTS Regulators advises increasing the pipe one nominal size every ten feet to keep the flow restriction as low as possible.
- Keep the vent line length as short as possible to minimize the restriction and reduce the vent's tendency to cause regulator pulsation. c. Support the vent pipe to eliminate strain on the regulator diaphragm case.
- Always point outdoor vent pipes in the downward position to reduce the possibility of rain, snow, sleet, and other moisture entering the pipe. Install a bug screen in the end of the pipe.
- Do not locate the vent line terminus near windows, fans, or other ventilation equipment. See the installation instructions furnished with the regulator.
- Adhere to all applicable codes and regulations.
- If your vent pipe causes regulator pulsation, consult your sales representative or manufacturer.
- ROOTS Regulators strongly recommends running a separate vent line for each regulator. Headers with various installed devices can cause regulator malfunction.

---

**Caution** Ensure the end of the vent line is away from ANY potential ignition sources. It is the installer's responsibility to ensure the vent line is exhausting to a safe environment.

---

## INSTALLATION

---

**Warning** ROOTS Regulators does not endorse or warrant the completeness or accuracy of any third party regulator installation procedures or practices, unless otherwise provided in writing by ROOTS Regulators. Follow your company's standard operating procedures regarding the use of personal protection equipment (PPE). Adhere to guidelines issued by your company in addition to those given in this document when installing regulators.

---

- a. Remove all shipping plugs from the regulator inlet, outlet, and vent before installation.
- b. Verify the piping interior and regulator inlet and outlet are clean and free of dirt, pipe dope, and other debris. Dirt and other foreign materials entering the regulator can cause a loss of pressure control.
- c. Apply pipe joint sealant to the male pipe threads. Do not use pipe joint material on the regulator's female threads. Joint sealant could lodge in the regulator and cause a loss of pressure control.
- d. Gas must flow through the regulator's valve body in the direction cast on the regulator body. Gas flowing in the wrong direction can cause overpressure and result in damage to the regulator.
- e. The diaphragm casing can be mounted in any position relative to the body through a full 360° angle at 90° increments.
- f. When the regulator is installed OUTDOORS, the vent must always be positioned so that rain, snow, moisture or foreign particles cannot enter the vent opening. ROOTS Regulators recommends positioning the vent downward to avoid entry of water or other matter which could interfere with the proper operation of the regulator. The vent should be located away from building eaves, window openings, building air intakes and above the expected snow level at the site. The vent opening should be inspected periodically to insure it does not become blocked by foreign material as outlined in DOT PHMSA-RSPA-2004-19856.
- g. When the regulator is installed INDOORS, the vent must be piped to the outside atmosphere using the shortest length of pipe, the fewest possible pipe elbows, and a pipe diameter as large as the vent size or larger. USING VENT PIPE SMALLER THAN THE VENT CONNECTION LIMITS THE REGULATOR'S INTERNAL RELIEF VALVE CAPACITY. The outlet end of the pipe must be protected from moisture and the entrance of foreign particles. The regulator should be specified by the user with the size vent and pipe threads desired to make the vent pipe connection.

## STARTUP PROCEDURE

- a. Mount a pressure gauge downstream of the regulator to monitor the downstream pressure.
- b. With the downstream pressure valve closed, slowly open the inlet valve. The outlet pressure should rise to slightly more than the setpoint. Verify there are no leaks and all connections are tight.
- c. The regulator was preset at the factory to match order specifications. If necessary, adjust the outlet pressure by removing the seal cap on the top of the spring housing and adjusting the ferrule or screw inside the spring housing using a large flat-head screwdriver. With a small amount of gas flowing through the regulator, rotate the ferrule clockwise to raise the outlet pressure or counterclockwise to lower the outlet pressure.
- d. Replace the seal cap and check for leaks after the desired outlet pressure is achieved.

The regulator is ready for operation.

## SAFETY WARNING

This product, as of the date of manufacture, is designed and tested to conform to all governmental and industry safety standards as they may apply to the manufacturer. The purchaser/user of this product must comply with all fire control, building codes, and other safety regulations governing the application, installation, operation, and general use of this regulator to avoid leaking gas hazards resulting from improper installation, startup or use of this product.

ROOTS Regulators strongly recommends installation by a qualified professional and periodic inspection of pressure regulators (inspections may be required by local applicable codes or regulations).

Inspections should include checking for gas quality, cycle numbers, external environmental changes, and operating conditions that impact wear on the regulator's moving parts. To ensure safe and efficient operation of this product, replace worn or damaged parts found during inspection.

## Limited Warranty

ROOTS Regulators are subject to the terms and conditions of the Natural Gas Solutions North America, LLC General Terms & Conditions For Sale of Products, Parts and Services, and no other terms shall apply, unless agreed upon by the parties in writing. The Natural Gas Solutions North America, LLC General Terms & Conditions For Sale of Products, Parts and Services can be found on the Dresser Utility website: [dresserutility.com/forms-questionnaires-and-terms-conditions-sale](http://dresserutility.com/forms-questionnaires-and-terms-conditions-sale).

## Ordering Information

Specify:

1. Inlet and outlet connection size and type
2. Model number
3. Outlet pressure desired
4. Pilot needed
5. Inlet pressure range
6. Type of gas and maximum capacity required
7. Assembly position number (see chart above)
8. Special requirements such as tagging,  $\frac{1}{8}$ " pipe plug tap, seal wire, etc.

## ROOTS Regulators

16240 Port Northwest Drive

Houston, TX 77041

T: 1-800-521-1114

F: 1-800-335-5224

© 2024 Natural Gas Solutions North America, LLC – All rights reserved. Dresser Utility Solutions reserves the right to make changes in specifications and features shown herein, or discontinue the product described at any time without notice or obligation. Contact your Dresser Utility Solutions representative for the most current information. The Dresser Logo and all Trademarks containing the term "Dresser" are the property of Dresser, LLC, a subsidiary of Baker Hughes.

