

# Dresser Electronic Temperature Compensator (ETC)

Installation, Operation and Maintenance Manual



# Contents

1. Introduction	4
2. Design Characteristics	4
3. Receiving, Handling and Storage	4
4. Meter Start-Up	5
5. Meter Maintenance	6
5.1 Meter Lubrication	6
5.2 Meter Level	6
5.3 Cleaning and Flushing	6
5.4 Differential Pressure Testing	6
6. Recommended Installation/Maintenance Tools for ETC Index	7
7. LCD Display	7
7.1 LCD Screen Displays	7
7.2 Data Display Screen and Icons	9
8. ETC Mounting Instructions	9
8.1 Removing Existing Unit	9
8.1.1 Remove Existing Unit on Series B Meters	9
8.1.2 Remove Existing Unit on Series A Meters	10
8.2 Installing the ETC	11
8.2.1 Installing Circular Connector Version – without AMR mounting bracket	11
8.2.2 Installing AMR Version with Mounting Bracket	14
8.2.3 Proper AMR Bracket Installation	17
8.2.4 Remove AMR Bracket	19
8.2.5 Re-attach AMR Bracket	20
9. Pulse Output Connections	21
9.1 Pulse Output Wiring Instructions for Hazardous Locations	22
9.2 Circular Connector Version Pulse Output Wiring	22
9.3 AMR Version Pulse Output Wiring	24
9.4 Wiring the Itron Remote Gas Endpoint Device to the ETC	26
9.5 Confirm Itron Remote Gas Endpoint Device is Properly Mounted	27
10. Operation Mode	27
10.1 Volume Measurement	27
10.2 Temperature Measurement	29
10.3 Flow Rate	29
10.4 Faults and Alarms	29
10.5 Logging	31

11. Maintenance	32
11.1 Battery Replacement	32
11.1.1 Changing the Battery on Series B and Series A Meters- Circular Pulse Output Connector Version	33
11.1.2 Changing the Battery on Series B and Series A Meters– AMR Version	34
11.2 Temperature Probe Replacement	35
11.3 Cleaning, Chemicals List	36
12. Proving the ETC with Dresser Model 5 Transfer Prover	36
12.1 Establish IrDA Cable Connection	36
12.2 Set Prove Mode on the ETC	37
12.3 Prove Compensated Volume	37
12.4 Prove Non-Compensated Volume	38
12.5 Model 5 Prover Software Configuration	38
12.6 Explanation of Prover Configuration Screen	39
12.6.1 Left Side of Prover Configuration Screen	39
12.6.2 Top Right side of Prover Configuration Screen	39
12.6.3 Bottom Portion of Prover Configuration Screen	39
12.6.4 Adding Additional Test Points	39
13. Upgrading the Firmware in the ETC	40
13.1 Attach IrDA cable	40
13.2 Establish Communication for Firmware Upgrade	40
13.3 Firmware Upgrade Process	41
14. ETC Specifications	42
15. Warranty	43

## 1. Introduction

The Dresser Natural Gas Solutions (NGS) Electronic Temperature Compensator (ETC) is a direct replacement alternative for the existing Dresser mechanical Temperature Compensating (TC) indexes on Dresser Series B and Series A (LM-MA) meters.

The simple, easy to read ETC index provides accurate and reliable temperature and fixed factor pressure compensation. Dresser offers factory installation of the index, optional customization and configuration as well as installation of Automated Meter Reading (AMR) endpoints. The ETC is powered by a lithium battery with an average battery life of 20 years, and stores 150 days of hourly measurement data safely in the on-board non-volatile memory.

Transfer proving time is also dramatically reduced by using the ETC index. The ETC utilizes a one cable system to reduce proving time to less than five minutes. Provided as a standard feature on the ETC index, no special software or computer programs are required.

## 2. Design Characteristics

The ETC family of products provides the accuracy of a fully electronic TC for the Series B and Series A (LM-MA) meter bodies. The ETC housing is molded from a clear polycarbonate material and uses quad ring seals on the lid and meter mounting flange to provide excellent protection from water intrusion. The cover's smooth cylindrical design easily sheds rain and resists accumulations of snow, ice and dirt.

These units are permanently lubricated for long life and maintenance-free operation. The ETC is isolated from the pressure vessel and is not pressurized.

With an average 20-year battery life<sup>1</sup>, factory installation of the index, and the ability to request factory installation and configuration of the AMR endpoints, the ETC provides the consistency and dependability required for custody transfer applications.

The electronic display of the ETC is clearly visible throughout the stated temperature operating range of -40°F to 140°F (-40°C to 60°C) and provides accurate temperature measurement and compensation across the range as well. Temperature measurement accuracy is assured by the capability of the PT 1000 temperature probe in combination with the conductive, wall-hugging design of the temperature probe housing, which provides continuous contact with the meter's temperature probe well.

Two configurable Form A pulse outputs provide the volume output for Automated Meter Reading (AMR) endpoints. A convenient mounting platform is available for directly mounting an AMR device to the ETC. The low-profile AMR platform conceals the pulse output cabling to help prevent tampering. Factory mounting and programming of AMR devices are available upon request.



In conjunction with the expanded lifespan of today's AMR devices, the ETC provides an average lifespan of 20 years. The ETC uses a twin cell, CSA-certified lithium battery pack with protective circuitry, thus allowing for safely changing the battery pack in the field.

Accuracy testing with the Dresser Model 5 Transfer Prover is simplified via the ETC infrared proving interface. The one-cable design provides a convenient method of establishing the connection between the ETC index and the Model 5 Prover.

Communication with the ETC is quick and simple with the use of the Dresser MeterWare user interface software and infrared communication cable. This software is presented in a user-friendly format and is common to several other Dresser meter and instrument products.

<sup>1</sup>Refer to section 11.1 for more information on battery life.

## 3. Receiving, Handling and Storage

**Do not accept any shipment that has evidence of mishandling in transit without making an immediate inspection of package for damage. If shipped as part of a meter assembly, the meter should be checked for free rotation soon after arrival as damage to internal working parts can exist without obvious external evidence.**

### At Time of Delivery

1. Check the packing list to account for all items received
2. Inspect each item for damage
3. Record any visible damage or shortages on the delivery record
  - a. File a claim with the carrier if necessary
  - b. Notify your Dresser Meter supplier immediately

## Reporting a Problem

Our Product Services Department offers professional services for all Dresser Meters and Instruments products. Authorization for return is required for all products shipped to the Factory for repair, calibration, warranty, exchange or credit. To obtain authorization, a Return Materials Authorization (RMA) number for return of Dresser products must be issued. Please contact your Dresser meter supplier.

### When reporting a suspected problem, please provide the following information:

1. Your purchase order number and/or Dresser 's sales order number
2. The product model, serial number and bill of material number
3. A description of the problem
4. Application information, such as gas type, pressure, temperature and flow characteristics

All returns should be packaged in an original-type shipping container, if available, or shipping material that will protect the product.

### Important Note

**Do not attempt repairs or adjustments, as doing so may be a basis for voiding all claims for warranty.**

## Storage/Initial Testing

If the product is not tested or installed soon after receipt, store in a dry location in the original shipping container for protection.

If any serious problems are encountered during installation or initial operation of the meter, notify your Dresser Meter supplier immediately.

### WARNING

This equipment is designed to operate at temperatures between -40° F to 140° F (-40°C to 60°C). Prior to going on-site for installation or maintenance, make sure proper safety equipment is worn before handling the equipment and that you are properly dressed for the work site environment temperatures.

## 4. Meter Start-Up

### WARNING

If equipment is installed/serviced/maintained at elevated heights, ensure proper safe site work practices are in place to prevent fall and drop hazards.

### WARNING

For installations in confined spaces, allow adequate room to safely handle product and equipment without causing bodily strain. Also verify proper ventilation is in place to maintain a breathable atmosphere.

For more detailed information on the operation of the actual meter bodies, refer to the following guides:

- Dresser Rotary Meter Series B3 Installation, Operation and Maintenance Manual (IOM:B3)
- Dresser Rotary Meter Series A (LM-MA) Installation, Operation and Maintenance Manual (IRM: LM-MA)

**Important:** The maximum working pressure of any rotary meter is limited by casing design. Meters shall not be installed where line pressure can exceed the Maximum Allowable Operating Pressure (MAOP). Refer to the basic meter body nameplate for the MAOP.

Slowly pressurize the meter in accordance with the following recommendations:

**Important:** Do not exceed 5 psig/second (35 kPa/second) maximum when pressurizing. Rapid pressurization can cause an over-speed condition which may damage the meter. Resulting damage is not covered by warranty.

1. Open the bypass and outlet (downstream of meter) gas valves.
2. Partially open the meter inlet gas valve until the meter starts operating at low speed.
3. It may be necessary to throttle the bypass valve to initiate gas flow through the meter:
  - a. Verify gas is flowing through the meter by scrolling to the Flow Rate screen on the LCD. The average flow rate for the last 30 seconds will be displayed. Ensure that there truly is a flow rate recorded.
4. Let the meter operate at low speed for several minutes.
  - a. Listen closely for unusual scraping or knocking sounds.
  - b. If operation is satisfactory, go directly to Step 6.
5. If unusual sounds are present:
  - a. Place the meter in bypass.
  - b. Slowly depressurize and vent all pressure from the meter set before checking for piping misalignment, piping strain, torsion, or other related problems. (Release pressure at a rate less than 5 psig/second.)
  - c. Once the problem is resolved, repeat the start-up procedure beginning with Step 1.



**Danger:** Slowly depressurize and vent all pressure from the meter set before working on the meter.

6. Gradually open the inlet valve until a full flow is passing through the meter and the inlet valve is fully open.
7. Slowly close the bypass valve.
8. Perform a leak test around the meter connections and the pressurized portion of the meter body housing.

#### WARNING

Follow your company's authorized procedures or common industry practices to leak test the meter and all pipe connections. Soapy water, Snoop® or gas analyzers are commonly used for this procedure.

## 5. Meter Maintenance

### 5.1 Meter Lubrication

While the ETC is oil free, the meter body still requires lubrication. Use only Dresser Meter Oil or other instrument grade oils approved for service by the manufacturer.

Meters installed and maintained in accordance with Factory recommendations can be expected to operate dependably for many years. Proper oil level and cleanliness have the greatest effect on the meter's life expectancy. Visually inspect the two oil reservoirs in the meter end covers for proper mid-gauge oil levels once a month until a practical interval is determined. Add oil as necessary.

Oil change frequency will depend upon the cleanliness of the gas being measured. Change oil when the color darkens or when the level changes. Under favorable conditions, these periods may be from three to five years, or longer.



**Caution: The Meter End Cover is Pressurized. Bleed off the line pressure before removing the oil fill or drain plugs from the meter.**

**Do NOT add oil to the ETC Index**

### 5.2 Meter Level

Since the meter is supported entirely by the gas pipe line, movement of the piping due to accidents, settling of the ground or other causes may impede meter operation and accuracy.

Refer to "Installation" procedures in the appropriate meter installation operation and maintenance manual.

Make sure the meter remains level within 1/16" per foot (5 mm/m) in any direction, side-to-side and front-to-back.

### 5.3 Cleaning and Flushing

**Note:** Before removing the meter from the pipeline or performing this procedure, drain all oil from the meter end covers. Add oil after the meter has been replaced in the meter set. After removing the meter from the line, if there is any evidence of dirt or dust in the meter, a suggested method for cleaning is to windmill the impellers (at a speed less than maximum capacity) by injecting low pressure, dry compressed air from a nozzle into the meter inlet. Flush approximately 5 ounces (150 ml) of an approved non-toxic, non-flammable solvent through the meter. Drain any residual cleaning fluid from the meter body and end covers. Use compressed air to completely dry the meter.

### 5.4 Differential Pressure Testing

Rotary meters are tested for accuracy by several industry accepted methods. These test methods include, but are not limited to transfer, bell, piston, sonic nozzle and critical flow proving.

The Differential Test is unique to rotary meters and is a convenient method of comparing a meter's performance to previous or original performance records. Differential testing is accepted by many state Utility Commissions as a means of periodically verifying that the original accuracy of a meter has remained unchanged.

The flow rate indication on the ETC is useful when performing a Differential Test. Refer to Section 7 for activating and viewing the meter flow rate.

For more information on Differential Pressure Testing, please refer to Dresser Rotary Meter Series B3 Installation, Operation and Maintenance Manual (IOM:B3) and Dresser Rotary Meter Series A (LM-MA) Installation, Operation and Maintenance Manual (IRM-LM-MA).

## 6. Recommended Installation/Maintenance Tools for ETC Index

### Suggested Tools

- Adjustable torque wrench/driver
- 5/32" hex wrench/driver
- 9/64" hex wrench/driver
- Phillips-head screw driver
- Needle nose pliers
- #2 Philips screw driver
- 3/8" box end wrench

### Items Provided with Repair Assembly #400

- Four short (3/4") screws for mounting without an AMR bracket
- or-
- Two short (3/4") and two long (7/8") screws for mounting with an AMR bracket
- Desiccant packet

### Infrared (IR) Communications Kit (Purchased separately)

- IR Sensor (USB connection)
- Holder-IR Assembly
- USB cable
- Magnet
- Dresser MeterWare Software

### Dresser Model 5 Prover Interface (Purchased separately)

- IR Prover cable
- Holder-IR Prover cable

## 7. LCD Display

Scrolling through the screen displays and connecting to the ETC requires use of the magnet. The magnet can be purchased as part of the Communications Kit, P/N 060542-000 or as an individual item, P/N 060541-000. Consult Factory for pricing. The Dresser MeterWare software is also available as a separate item.

Swipe the magnet across the "swipe line" on the label as shown in Figures 7.1 and 7.2.

**Note:** The magnet will not change screen displays if swiped on another area of the label.



Figure 7.1-Label on ETC



Figure 7.2-Swipe magnet across the swipe line to change the screen displays

### 7.1 LCD Screen Displays

1. The default screen is either Compensated Volume or Non-Compensated Volume, depending on customer configuration.
  - a. This parameter is the home/default screen.
  - b. After a time out of approximately 30 seconds, the home screen always will appear.
2. Repeat the swiping motion of the magnet across the swipe line, and the screens always will appear in the following sequential order as shown in Table 1.

**Note:** Using the Dresser MeterWare Software, the screens are configured by checking and un-checking the parameter to be displayed. Depending on the ETC configuration, some screens may not appear.
3. Three to five seconds after the name of the value or the parameter appears, the screen will switch to show you the value of the selected parameter.

**Table 1**-Scrolling sequence for ETC screen display

Displayed on Screen	Represents	Function
COMPENSATED VOLUME	Compensated Volume	Displays non-compensated volume which has been corrected to standard conditions
NON-COMPENSATED VOLUME	Non-compensated Volume	Displays actual non-compensated volume
LINETEMP	Line Temperature	Displays live line temperature
FIXED P	Fixed Line Temperature	Displays the line pressure as entered by the user
FLOWRATE	Flow Rate	Displays uncorrected flow rate (average of latest 30 seconds of captured data)
MTR INFO	Meter Info	Meter size and type
PROVE CV	Compensated Prove Mode	Allows for compensated volume accuracy testing
PROVE UV	Non-compensated Prove Mode	Allows for non-compensated volume accuracy testing
BATTVOLT	Battery Voltage	Displays battery voltage
REM LIFE	Remaining Life	Calculated remaining battery life—shown in months
FIRM REV	Firmware Revisions	Displays the firmware revision that is in the ETC at the present time
LCD TEST	LCD Test	Tests all display segments
BATTCHNG	Change Battery	Saves data to memory and resets clock
COMPFCTR	Compensation Factor	Displays the factor applied to non-compensated volume in order to arrive at compensated volume
COMPENSATED RESIDUAL	Compensated Residual	Shows extended compensated volume data beyond the value shown in the compensated volume screen
NON-COMPENSATED RESIDUAL	Non-compensated Residual	Shows extended non-compensated volume data beyond the value shown in the non-compensated volume screen
BASE T	Base Temperature	Displays base temperature as entered by the user
BASE P	Base Pressure	Displays base pressure as entered by the user
ATMOS	Atmospheric Pressure	Displays average atmospheric pressure as entered by the user
NCVOLFLT	Non-compensated volume under fault	Displays non-compensated volume that has accumulated since a fault occurred



## 7.2 Data Display Screen and Icons

- A. Data will be displayed in digital format as shown in Figure 7.3.
- B. Individual icons will display depending on the function or parameter, and how you have configured the ETC using the Dresser MeterWare software. Refer to Section 10 for more information. Refer to Table 2 for icon descriptions.

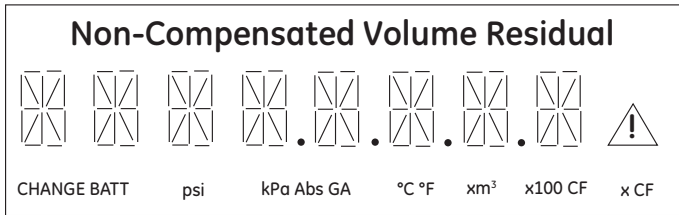


Figure 7.3-Data Display Screen

Table 2-Icon descriptions

Icon	Description
CHANGE BATT	Change Battery
psi	Pounds per square inch
kPa	Kilopascal
Abs	Absolute
GA	Gauge
°C	Temperature in Celsius
°F	Temperature in Fahrenheit
xm <sup>3</sup>	Times meters cubed
x100 CF	Times 100 cubic feet
x CF	Times cubic feet
	Alarm/Fault has occurred; consult software manual

## 8. ETC Mounting Instructions

### 8.1 Remove Existing Unit

#### 8.1.1 Removing the Existing Unit on Series B Meters

In order to install the ETC, you must remove the existing accessory unit. Refer to Figure 8.1.

- A. Use a 5/32-inch hex wrench to remove the four hex screws attaching the existing accessory unit to the meter.

**Note:** while there is no required order for removing the screws, if the unit is side mounted, it is helpful to leave a screw at the top until last.

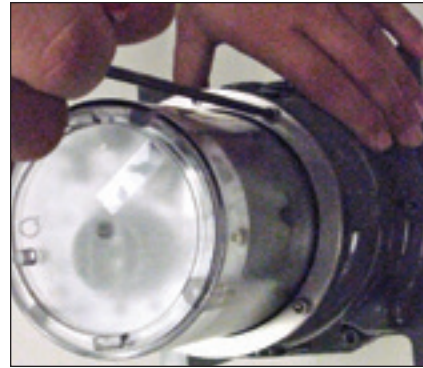


Figure 8.1-Remove four hex screws



Figure 8.2-Remove slip flange

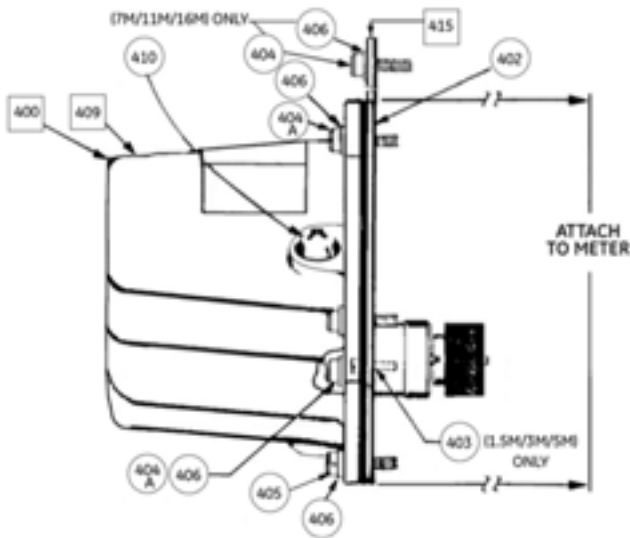
- B. Lift and remove slip flange ring as shown in Figure 8.2.
- Note:** The ETC installation does not require this slip flange.
- C. Carefully pull the unit straight out from the meter body.
- D. Remove the existing desiccant pack, and clean the end cover if needed.

### 8.1.2 Removing the Existing Unit on Series A Meters

In order to install the ETC, you must remove the existing Series A accessory unit. Refer to Section I to remove CTR accessory units for meter sizes 1.5/3/5M, Section II for CTR accessory unit for meter sizes 7/11/16M, and Section III for TC accessory units.

#### I. Removing Series A CTR Accessory Unit-sizes 1.5/3/5M:

Refer to Figure 8.3 for Steps A-D.



**Figure 8.3**-Series A Counter Accessory Unit

- A. Remove the lower oil drain plug (410-not shown in picture) using a #2 Phillips screwdriver. Drain the oil and replace the self-sealing screw.
- B. Remove the cap screws (404A & 405) and washers (406) that hold the counter unit to the meter end cover.
- C. The adapter plate (415) on the 1.5M, 3M, 5M meters is retained to the meter end cover with one (1) cap screw (403) and may be sealed tight with the flat gasket (402). Remove this cap screw before trying to force the adapter plate off the meter end cover.
- D. Pull the complete assembly straight out from the meter end cover, being careful not to damage the magnet assembly or drive shaft. Remove the gasket (402) from the meter end cover and discard. If the counter assembly is to be used on another meter, store it with the cover fastened to it to prevent damage to the counter. None of the parts from this unit are needed for ETC unit installation.

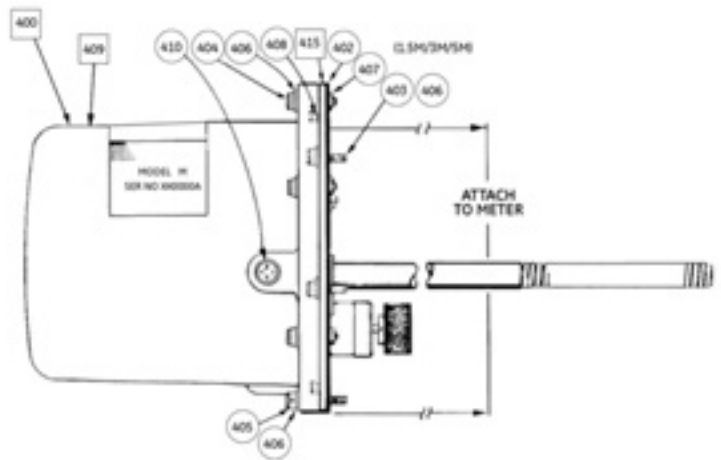
#### II. Removing Series A CTR Accessory Unit- sizes 7/11/16M:

Refer to Figure 8.3 for Steps A-D.

- A. Remove the lower oil drain plug (410-not shown in picture) using a #2 Phillips screwdriver. Drain the oil and replace the self-sealing screw.
- B. Remove the socket head cap screws (404A, 405) and washers (406) and pull off the plastic counter cover.
- C. Next, remove the cap screws (404) and washers (406) that hold the counter unit to the meter end cover.
- D. Pull the complete assembly straight out from the meter end cover, being careful not to damage the magnet assembly or drive shaft. Remove the gasket (402) from the meter end cover and discard. None of the parts from this unit are needed for ETC unit installation.

#### III. Removing Series ATC Accessory Units:

Refer to Figure 8.4 for Steps A-D.



**Figure 8.4**-Series A TC Accessory Unit

- A. Remove the lower oil drain plug (410-not shown in picture) using a #2 Phillips screwdriver. Drain the oil and replace the self-sealing screw.
- B. Remove the five screws (404) and washers (406). Also remove the lock nuts (407) that are used on 1.5M, 3M and 5M aluminum body meters. Remove the remaining cap screw and washer (405 & 406). The cover (409) is sealed to the adapter plate by an "O" ring (408). Use caution in removing the cover to prevent damage to the counter shafts, masks and the dials.
- C. On aluminum body meters, there are four (4) cap screws (403) that hold the adapter plate (415) of the TC to the meter end cover. Remove these using the proper size socket head wrench. The cast iron body meters will have two socket head screws (403) which must be removed.

- D. Pull the TC unit out straight from the meter body and temperature well. Use caution to not damage the bi-metallic temperature probe during removal. After removal, replace the plastic cover onto the TC unit with at least one screw and nut to prevent damage. Store the complete unit such that the probe will not be damaged. None of the parts from this unit are needed for ETC accessory unit installation.

## 8.2 Installing the ETC

### 8.2.1 Installing the ETC Circular Connector Version – (without AMR mounting bracket)

If installing with AMR mounting bracket, move to section 8.2.2

#### I. Installing the ETC Circular Connector Version on Series B Meters

The following steps instruct how to mount the ETC with Circular Connector on a Series B Meter, as shown in Figure 8.5.

**Note:** Make sure the ETC is configured to the meter size it is being installed to.

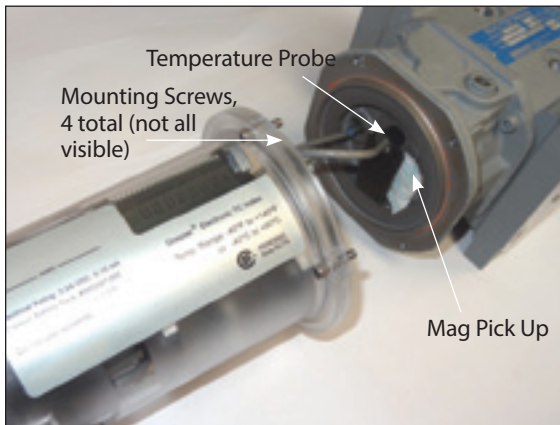


Figure 8.5-ETC with Circular Connector on a Series B Meter

- A. Apply the new desiccant pack by peeling the adhesive backing and applying to the unit, as indicated in Figure 8.6.



Figure 8.6-New desiccant pack in place

- B. Remove the ETC from the static bag, as shown in Figure 8.7.



Figure 8.7-ETC removed from static bag.

- C. Unhook and remove the bead tie wraps as shown in Figure 8.8 below, and remove the protective cardboard cover. Dispose of the cardboard cover and tie wrap properly.



Figure 8.8-Remove cardboard cover

- D. Ensure the Orange O-ring seal, P/N 013808-158 is seated into the circular groove in the index cover as shown in Figure 8.9.

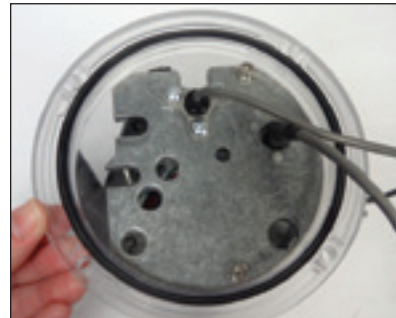


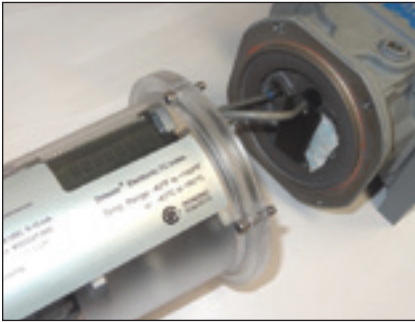
Figure 8.9-Orange O-ring seal seated in circular groove.

- E. Holding the ETC in front of the meter body, align the temperature probe with the probe well, and guide the probe into the well as shown in Figure 8.10.



Figure 8.10-Insert temperature probe

- F. While guiding the temperature probe into the temperature probe well, make sure the mag pick-up comes into alignment with the magnet well, as shown in Figure 8.11.
- G. Seat the mag pick-up in the magnet well.



**Figure 8.11**-Seat mag pick-up in magnet well

- H. Using the four 5/32-inch screws provided:
  1. Insert the screws in the top mounting holes
  2. Insert the screws in the lower mounting holes
  3. Using the 5/32-inch hex wrench, tighten the four screws just enough to hold the unit temporarily
  4. Working in a cross pattern, tighten all screws to 12-14 inch pounds using a torque wrench as shown in Figure 8.12.

**Important:** Do not exceed this torque as damage may occur to the housing cover at higher torque values.



**Figure 8.12**-Torque mounting screws to a maximum of 12-14 inch-pounds.

## II. Installing the ETC Circular Connector Version on Series A Meters

**Note:** Make sure the ETC is configured to the meter size it is being installed to.

- A. Apply the new desiccant pack by peeling the adhesive backing and applying to the unit as shown in Figure 8.13.



**Figure 8.13**-New desiccant pack in place.

- B. Remove the ETC from the static bag as shown in Figure 8.14.



**Figure 8.14**-ETC removed from static bag

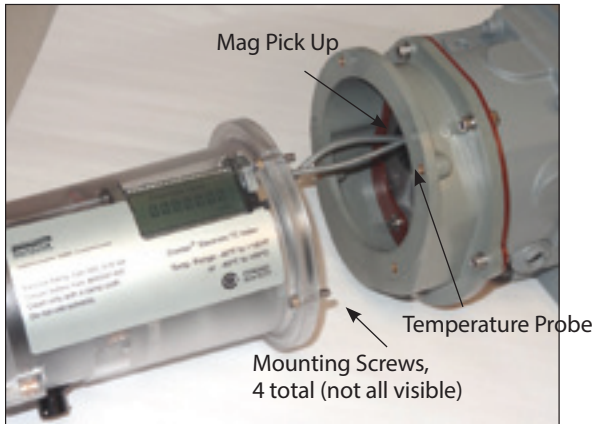
- C. Unhook and remove the bead tie wraps to remove the cardboard covering as shown in Figure 8.15. Dispose of the cardboard cover and tie wrap properly.



**Figure 8.15**-Remove cardboard cover

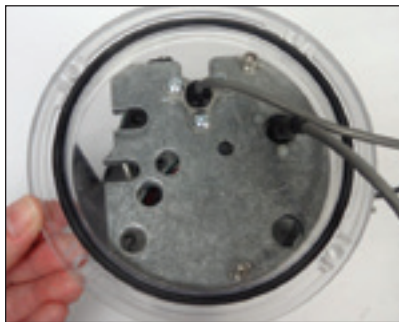


Figure 8.16 illustrates an exploded view of the ETC unit as assembled on Series A meters.



**Figure 8.16**-Exploded view of assembling the ETC on Series A meters.

- D. Ensure the Orange O-ring seal, P/N 013808-158 is seated into the circular groove in the index cover as shown in Figure 8.17.



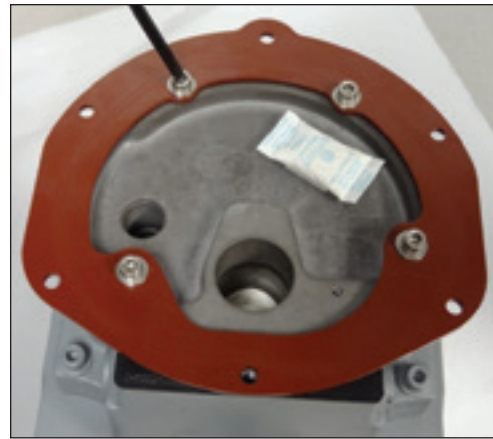
**Figure 8.17**-Orange O-ring seal seated in circular groove

- E. Place the interface gasket, onto the meter body and line up the holes as shown in Figure 8.18. Please note there are (2) gasket sizes in the kit. Use the gasket appropriate in size for the meter.



**Figure 8.18**-Interface gasket placed on meter body

- F. Place the brown adapter plate, P/N 060712-000, on top of the interface gasket and align the holes as shown in Figure 8.19. Use a 5/32 Allen wrench to tighten the four (4) supplied 10-24 X 1/2" cap screws and four (4) plain washers to 12 inch-pounds torque.



**Figure 8.19**-Adapter Plate installed on meter body.

- G. Ensure the Quad ring seal, P/N 013456-251 is seated properly into the groove of the adapter housing as shown in Figure 8.20.



**Figure 8.20**-Quad ring seal seated into groove.

- H. Place the Lexan Adapter Housing, P/N 058171-000 onto the Adapter Plate and line up the holes so the mating surfaces/profile match as shown in Figure 8.21.



**Figure 8.21**-Lexan Adapter Housing placed on top of the adapter plate.

- I. Install the five 10-24 X 3/4" cap screws with hex lock nuts, one drilled head 10-24 X 3/4" cap screw and six plain washers onto the Adapter plate as shown in Figure 8.22 using an 5/32 Allen wrench. Working in a cross pattern, tighten the five hex lock nuts to the cap screws on the bottom side of the Adapter plate using a 3/8" box end wrench, and torque to 12 inch-pounds.



**Figure 8.22**-Install cap screws, washers and hex lock nuts.

- J. While guiding the temperature probe into the temperature probe well, make sure the mag pick-up comes into alignment with the magnet well, as shown in Figure 8.23.
- K. Seat the mag pick-up in the magnet well.



**Figure 8.23**-Seat mag pick-up in magnet well

- L. Gently adjust the ETC to the mating surface of the Lexan Adapter Housing and line up the threaded holes to seat the unit on the meter body.
- M. Using the four 5/32" screws that are provided:
  1. Insert the screws into the top mounting holes
  2. Insert the screws into the lower mounting holes
  3. Using the 5/32" hex wrench, tighten the four screws just enough to hold the unit temporarily
  4. Working in a cross pattern, tighten all screws to 12-14 inch pounds using a torque wrench as shown in Figure 8.24.

**Important:** Do not exceed this torque as damage may occur to the housing cover at higher torque values.



**Figure 8.24**-Torque mounting screws to a maximum of 12-14 inch-pounds

## 8.2.2 Installing the ETC AMR Version with Mounting Bracket

### I. Installing the ETC AMR Version on Series B Meters

The following steps instruct how to mount the ETC with AMR mounting bracket on a Series B Meter.

**Note:** Make sure the ETC is configured to the meter size it is being installed to.

- A. Apply the new desiccant pack by peeling the adhesive backing and applying to the unit as indicated in Figure 8.25.



**Figure 8.25**-New desiccant pack in place

- B. Remove the ETC from the static bag as shown in Figure 8.26.



**Figure 8.26**-ETC removed from static bag.

- C. The AMR bracket is temporarily held to the ETC by tie wraps. Unhook and remove the bead tie wraps to remove the cardboard covering and to release the AMR bracket as shown in Figure 8.27. Dispose of the cardboard cover and tie wrap properly.



Figure 8.27-Remove cardboard cover

- D. Ensure the Orange O-ring seal, P/N 013808-158 is seated properly into the circular groove in the index cover as shown in Figure 8.28.

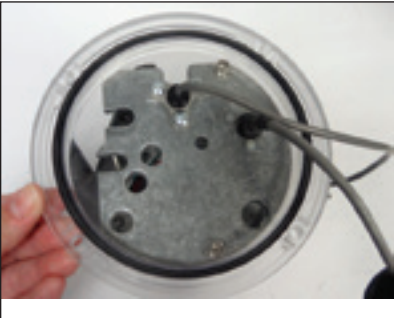


Figure 8.28-Orange O-ring seal seated in circular groove

- E. Holding the ETC in front of the meter body, align the temperature probe with the probe well, and guide the probe into the well as shown in Figure 8.29.



Figure 8.29-Insert temperature probe

- F. While guiding the temperature probe into the temperature probe well, make sure the mag pick-up comes into alignment with the magnet well, as shown in Figure 8.30.
- G. Seat the mag pick-up in the magnet well.



Figure 8.30-Seat mag pick-up in magnet well

- H. Gently adjust the ETC until it is seated on the meter body. Refer to Section 8.2.3 for AMR bracket installation.

## II. Installing the ETC AMR Version on Series A Meters

**Note:** Make sure the ETC is configured to the meter size it is being installed to.

- A. Apply the new desiccant pack by peeling the adhesive backing and applying to the unit as shown in Figure 8.31.



Figure 8.31-New desiccant pack in place.

- B. Remove the ETC from the static bag as shown in Figure 8.32.



Figure 8.32-ETC removed from static bag

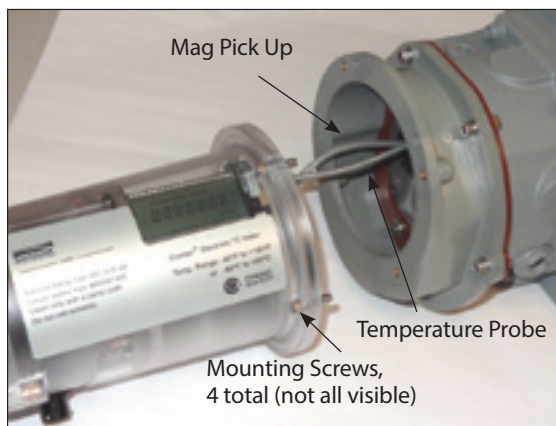


- C. Unhook and remove the bead tie wraps to remove the cardboard covering as shown in Figure 8.33. Dispose of the cardboard cover and tie wrap properly.



**Figure 8.33**-Remove cardboard cover

Figure 8.34 illustrates an exploded view of the ETC unit as assembled on Series A meters.



**Figure 8.34**-Exploded view of assembling the ETC on Series A meters.

- D. Ensure the Orange O-ring seal, P/N 013808-158 is seated into the circular groove in the index cover as shown in Figure 8.35.



**Figure 8.35**-Orange O-ring seal seated in circular groove

- E. Place the interface gasket, P/N 013456-251, onto the meter body and line up the holes as shown in Figure 8.36. Please note there are 2 gasket sizes in the kit. Use the gasket appropriate in size for the meter.



**Figure 8.36**-Interface gasket placed on meter body

- F. Place the brown adapter plate, P/N 060712-000, on top of the interface gasket and align the holes as shown in Figure 8.37. Use a 5/32 Allen Wrench to tighten the four (4) supplied 10-24 X 1/2" cap screws and four (4) plain washers to 12 inch-pounds torque.



**Figure 8.37**-Adapter Plate installed on meter body.

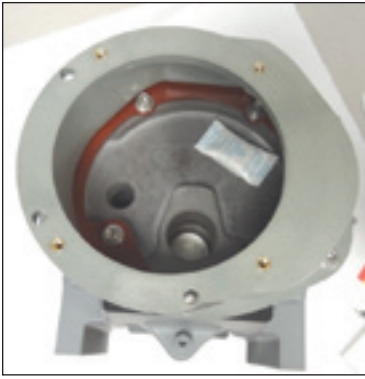
- G. Ensure the O-ring seal, P/N 013456-244 is seated properly into the groove of the adapter housing as shown in Figure 8.38.



**Figure 8.38**-O-ring seal seated into groove.

- H. Place the Lexan Adapter Housing, P/N 058171-000 onto the Adapter Plate and line up the holes so the mating surfaces/profile match as shown in Figure 8.39.





**Figure 8.39**-Lexan Adapter Housing placed on top of the adapter plate.

- I. Install the five 10-24 X 3/4" cap screws with hex lock nuts, one drilled head 10-24 X 3/4" cap screw and six plain washers onto the Adapter plate as shown in Figure 8.40 using a 5/32 Allen Wrench. Working in a cross pattern, tighten the five hex lock nuts to the cap screws on the bottom side of the Adapter plate using a 3/8" box end wrench to 12 inch-pounds.



**Figure 8.40**-Install cap screws, washers and hex lock nuts.

- J. While guiding the temperature probe into the temperature probe well, make sure the mag pick-up comes into alignment with the magnet well, as shown in Figure 8.41.
- K. Seat the mag pick-up in the magnet well. Refer to Section 8.2.3 for AMR bracket installation.



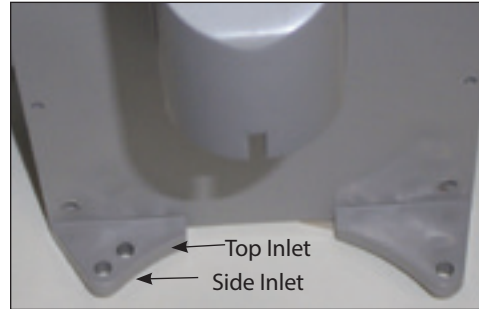
**Figure 8.41**-Seat mag pick-up in magnet well

### 8.2.3 Proper AMR Bracket Installation

There are two ways the AMR bracket can be installed: top or side inlet:

1. For top inlet, the AMR bracket is directly opposite the odometer.
2. For side inlet, the AMR bracket is on top (or 90°) from the odometer.

Note the location of the screw holes for top vs. side installation as shown in Figure 8.42.



**Figure 8.42**-Location of screw holes

#### Top Inlet Orientation:

- A. Insert one 3/4-inch (short) screw on the unit below the odometer, and tighten with the 5/32-inch hex wrench just enough to hold the unit temporarily as shown in Figure 8.43. Do not fully tighten at this point.



**Figure 8.43**-Insert the 3/4-inch (short) screw

- B. Align the AMR bracket; placing the cable gland connector into the recess on the end of the accessory unit, as shown in Figure 8.44.



**Figure 8.44**-Place cable gland connector into recess

- C. Insert the two 7/8-inch (long) screws through the AMR bracket, and tighten with the 5/32-inch hex wrench until the bracket is in contact with the ETC housing. Do not fully tighten at this point. Refer to Figure 8.45. The other 7/8-inch screw will be mounted through the bracket opposite the screw as shown in Figure 8.45.



**Figure 8.45**-Insert the 7/8" (long) screws

- D. Insert the remaining 3/4-inch (short) screw into the open hole near the LCD display screen as shown in Figure 8.46.

**Note:** If a security wire is required, the wire can be connected through this drilled head screw near the LCD display screen.



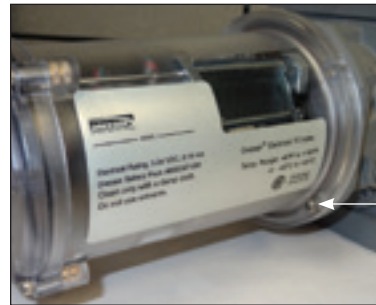
**Figure 8.46**-Insert the remaining 3/4 inch (short) screw

- E. Working in a cross pattern, tighten all screws to 12-14 inch-pounds using a torque wrench.

**Important:** Do not exceed this torque as damage may occur to the accessory unit cover at higher torque values

**Side Inlet Orientation:**

- A. Insert one 3/4-inch (short) screw on the unit below the odometer, and tighten with the 5/32-inch hex wrench just enough to hold the unit temporarily as shown in Figure 8.47. Do not fully tighten at this point.



**Figure 8.47**-Insert the 3/4-inch (short) screw

- B. Align the AMR bracket, placing the cable gland connector into the recess on the end of the accessory unit, as shown in Figure 8.48.



**Figure 8.48**-Place cable gland connector into recess

- C. Insert the two 7/8 -inch (long) screws through the AMR bracket, and tighten with the 5/32-inch hex wrench until the bracket is in contact with the ETC housing. Refer to Figure 8.49. Do not fully tighten at this point.

**Note:** If a security wire is required, the wire can be connected through this drilled head screw near the LCD display screen.



**Figure 8.49**-Insert the 7/8-inch (long) screws  
7/8" screws (one not shown)

- D. Insert the remaining 3/4-inch (short) screw into the open hole on the back side of the unit as shown in Figure 8.50

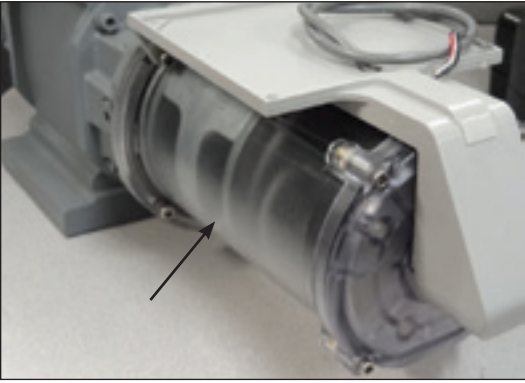


Figure 8.50-Insert the 3/4-inch (short) screw

- E. Working in a cross pattern, tighten all screws to 12-14 inch-pounds using a torque wrench.

**Important:** Do not exceed this torque as damage may occur to the accessory unit cover at higher torque values.

**Changing AMR Bracket Inlet Orientation if installed on a Series B or Series A Meter**

If the ETC was purchased already installed as a complete meter, the ETC will arrive from the factory with the AMR bracket set for top inlet orientation, as shown in Figure 8.51, unless previously specified to the factory.

This section explains changing bracket inlet orientation if required.



Figure 8.51-Top inlet orientation of AMR bracket

**8.2.4. Remove AMR Bracket**

**Note:** AMR bracket is shown in Figure 8.51 as top inlet position, however these instructions apply to either top or side inlet orientations.

- A. Using a 5/32-inch hex wrench, remove the two screws that hold the AMR bracket to the ETC unit, as shown in Figures 8.52 and 8.53.
- B. Do not remove the screw that is under the odometer (see Figure 8.54), as it holds the ETC unit to the meter while you remove the other short screw.
- C. Retain the three screws for re-attaching the AMR bracket.



Figure 8.52-Remove screws attached to AMR bracket



Figure 8.53-Remove screws attached to AMR bracket



Figure 8.54-Leave screw under odometer in place



### 8.2.5 Re-attach AMR Bracket

#### Top Inlet Orientation:

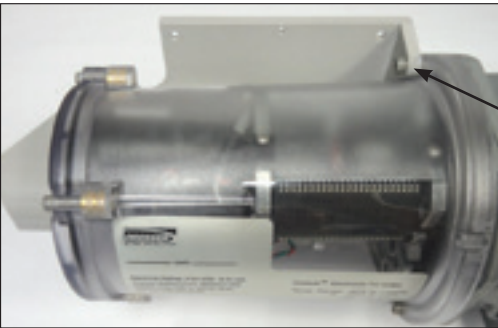
- A. Align the AMR bracket; placing the cable gland connector into the recess on the end of the accessory unit, as shown in Figure 8.55.



Figure 8.55-Place cable gland connector into recess

- B. Insert the two 7/8-inch (long) screws through the AMR bracket, and tighten with the 5/32-inch hex wrench until the bracket is in contact with the ETC housing. Refer to Figure 8.56. The other 7/8-inch screw will be mounted through the bracket opposite the screw shown in Figure 8.56.

**Note:** Do not tighten at this point.



7/8"  
screws  
(one not  
shown)

Figure 8.56-Insert the 7/8" (long) screws

- C. Insert the remaining 3/4-inch (short) screw into the open hole near the LCD display screen as shown in Figure 8.57. Do not tighten.

**Note:** If a security wire is required, the wire can be connected through this drilled head screw near the LCD display screen.



Figure 8.57-Insert the 3/4-inch (short) screw

- D. Working in a cross pattern, tighten all screws to 12-14 inch-pounds using a torque wrench.

**Important:** Do not exceed this torque as damage may occur to the accessory unit cover at higher torque values.

#### Side Inlet Orientation:

- A. Align the AMR bracket, place the cable gland connector into the recess on the end of the accessory unit, as shown in Figure 8.58.



Figure 8.58-Place cable gland connector into recess

- B. Insert the two 7/8-inch (long) screws through the AMR bracket, and tighten with the 5/32-inch hex wrench until the bracket is in contact with the ETC housing. Refer to Figure 8.59. Do not tighten at this point. The other 7/8-inch screw will be mounted opposite the screw shown in Figure 8.59.

**Note:** If a security wire is required, the wire can be connected through this drilled head screw near the LCD display screen.



Figure 8.59-Insert the 7/8-inch (long) screws

7/8"  
screws  
(one not  
shown)

- C. Insert the remaining 3/4-inch (short) screw into the open hole on the back side of the unit as shown in Figure 8.60. Do not tighten.



Figure 8.60-Insert the 3/4-inch (short) screw

- D. Working in a cross pattern, tighten all screws to 12-14 inch-pounds using a torque wrench.

**Important:** Do not exceed this torque as damage may occur to the accessory unit cover at higher torque values.

## 9. Pulse Output Connections

The ETC provides pulse outputs for both a circular pulse output connector and an AMR cable output. Using the Dresser MeterWare software, the Corrector pulse output allocation is configured in the Volume configuration screen, as shown in Figure 9.1. Refer to this screen to verify proper configuration. Refer to the MeterWare Manual for complete operating instructions.

**Note:** Some customers will have their ETC configured by the factory. Verify your company policy prior to making any configuration changes.

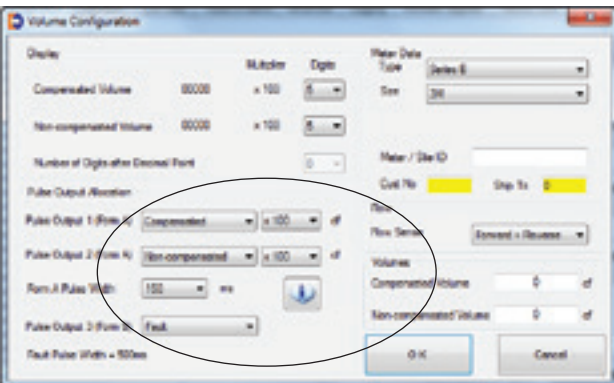


Figure 9.1-Volume Configuration screen in Dresser MeterWare

To help ensure the your pulse outputs are properly wired, the MeterWare software has a test function available on the Advanced screen, as shown in Figure 9.2.

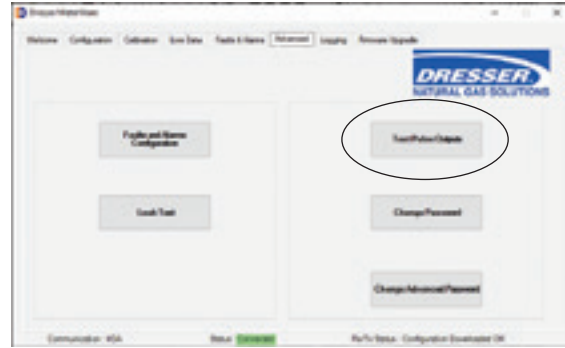


Figure 9.2-Advanced Screen in MeterWare Software

Once you click the Test Pulse Outputs button, a screen will appear as shown in Figure 9.3. Click Yes to proceed with the pulse output test. For further information, refer to the MeterWare Manual.

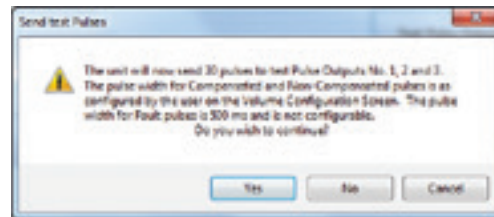


Figure 9.3-Send test Pulses screen in Dresser MeterWare

**Note:** For more information on configuring and testing pulse outputs, consult the Dresser MeterWare manual.

## 9.1 Pulse Output Wiring Instructions for Hazardous Locations

To maintain compliance with CSA certification, use a suitable Intrinsic Safety barrier for a Class 1, Division 1 hazardous area for groups A, B, C and D:

1. Do not exceed the following input values for the barrier device:
  - a.  $V_i=8.2V$
  - b.  $I_i=10ma$
2. The OUTPUT and power handling capability of a barrier should not exceed:
  - a.  $V_{out}=30V$
  - b.  $I_{out}=50ma$

For hazardous areas, use a recommended barrier such as Turck Brand IM1-12EX-T Single Channel or IM1-22 EX-R Dual Channel Barrier or an equivalent.

Wiring diagrams are provided for the Circular Connector Version and AMR Versions of the ETC in Sections 9.2 and 9.3 respectively.

### WARNING

Ensure properly licensed/trained professionals are used to install equipment if installed in hazardous locations containing explosive atmospheres. All local codes and standards shall be maintained during installation.

### WARNING

Products certified as intrinsically safe installations shall be:

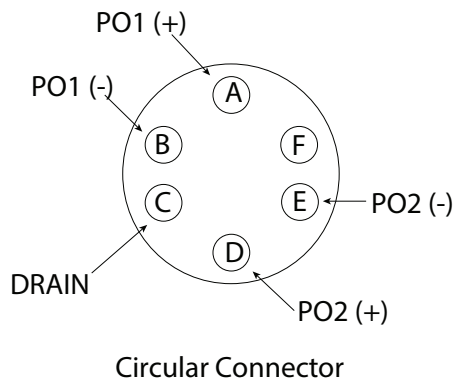
- Installed, put into service, used and maintained in compliance with national and local regulations and in accordance with the recommendations contained in the relevant standards concerning potentially explosive atmospheres.
- Used only in situations complying with the certification conditions shown in this document and after verification of their compatibility with the zone of intended use and the permitted maximum ambient temperature.
- Installed, put into service and maintained by qualified and competent professionals who have undergone suitable training for instrumentation used in areas with potentially explosive atmospheres.

## 9.2 Circular Connector Version Pulse Output Wiring

See Table 1 and Figure 9.4 for output pulse wiring for Circular Connector.

**Table 1**—Circular Connector Pulse Wiring

Output	Name	Connector Pin	Pulse Type
Pulse Output 1 (+)	PO1 (+)	A	Form A
Pulse Output 1 (-)	PO1 (-)	B	
Drain	(Drain)	C	—
Pulse Output 2 (+)	PO2 (+)	D	Form A
Pulse Output 2 (-)	PO2 (-)	E	



**Fig 9.4**—Circular Connector

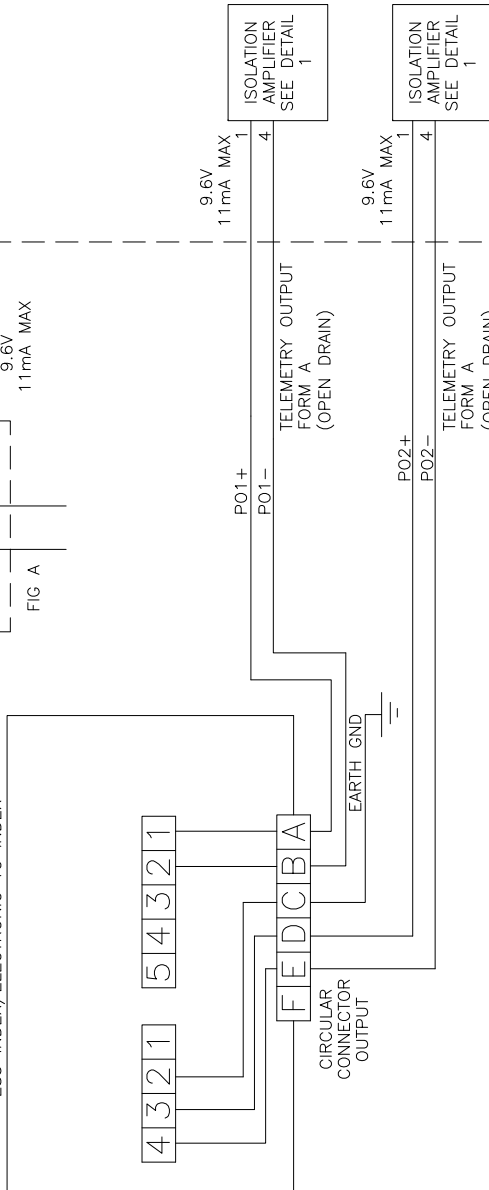
**Note:** The Circular mating connector is available with 5, 10, or 20 feet of cable. Contact factory for price, part number and availability.

NON\_HAZARDOUS\_AREA

HAZARDOUS AREA  
(CLASS 1, DIVISION 1, GROUPS A, B, C AND D)

FORM A AND OR FORM B PULSE OUTPUTS MAY BE CONNECTED INDEPENDENTLY TO EITHER ONE RADIO TELEMETRY DEVICE (FIG A) IN THE HAZARDOUS AREA OR, ONE WIRELINE TELEMETRY UNIT (FIG B) IN THE NONHAZARDOUS AREA.

ES3 INDEX/ELECTRONIC TC INDEX



USE EARTH GROUND WHEN ONLY USING AMR CONNECTED TELEMETRY.

USE INTRINSIC SAFETY GROUND BUSS IN THE NON HAZARDOUS AREA IF USING EVEN ONE WIRELINE TELEMETRY CONNECTION.

NEVER ATTACH BOTH GROUND CONNECTIONS.

MULTIPLE CONNECTIONS OF ANY ONE OUTPUT TO MORE THAN ONE DEVICE IS PROHIBITED.

NOTE PULSE OUTPUT SIGNAL POLARITY GOING TO EITHER AN AMR OR ISOLATION AMPLIFIER UNIT.

FORM A AND FORM B PULSE CONNECTIONS TRANSMITTED TO ISOLATION AMPLIFIERS AND OR, AMR UNITS.

HAZARDOUS AREA INSTALLATIONS IN CANADA MUST BE INSTALLED IN ACCORDANCE WITH THE CANADIAN ELECTRICAL CODE (CEC) PART 1.  
HAZARDOUS AREA INSTALLATIONS IN THE UNITED STATES MUST BE INSTALLED IN ACCORDANCE WITH THE NATIONAL ELECTRIC CODE (NEC).

ALL INTRINSICALLY SAFE WIRING MUST BE SEPERATED FROM ANY OTHER SAFE ZONE WIRING BY AT LEAST 2 INCHES IN A SEPARATE PANDUIT.

USE TURCK IM1-12EX-T SINGLE CHANNEL, IM1-22 EX-R DUAL CHANNEL ISOLATION AMPLIFIERS OR, EQUIVALENT WHICH ARE CAPABLE OF HIGH SPEED SWITCHING RESPONSE.

EITHER NORMALLY OPEN OR NORMALLY CLOSED OUTPUT MAY BE SELECTED WITH THE, "NO/NC" ISO-AMP SWITCH IN THE FRONT OF THESE UNITS. PULSE FORM MAY BE SELECTED PER REQUIREMENTS OF THE LOGGING SYSTEM USED.

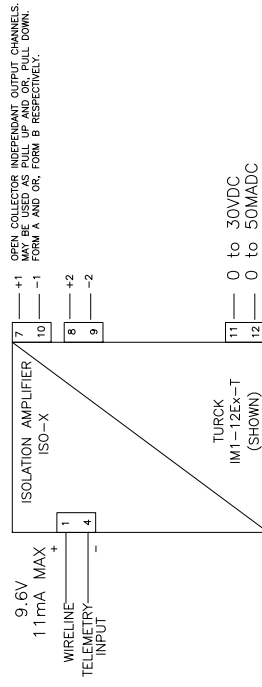


FIGURE B  
DETAIL 1

Figure 9.5-Wiring diagram for hazardous locations (Circular Connector version-060793-000)

### 9.3 AMR Version Pulse Output Wiring

The ETC provides pulse outputs from both an AMR cable output and a circular pulse output connector as shown in Figures 9.6 and 9.7. Reference Tables 2 and 3 for the appropriate wiring configuration outputs.

The pulse outputs are configurable utilizing the Dresser MeterWare software. For more information, consult the Dresser MeterWare manual.

**Note:** The Circular mating connector is available with 5, 10, or 20 feet of cable. Contact Factory for price, part number and availability.

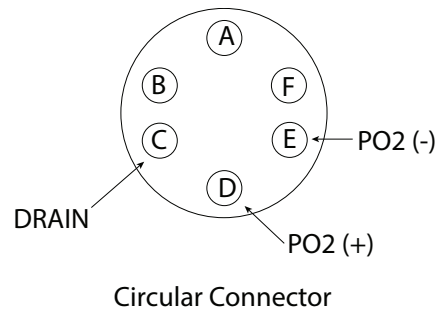


Figure 9.7-Circular connector

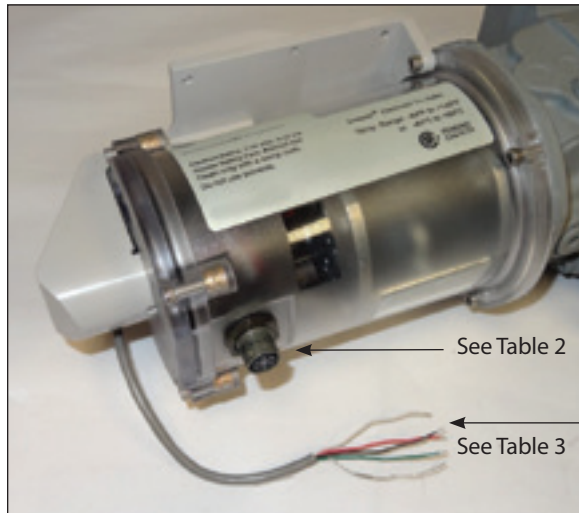


Figure 9.6-ETC with AMR Cable

Table 3-AMR Cable

Output	Name	Wire Color	Pulse Type
Pulse Output 1 (+)	PO1 (+)	White	Form A
Pulse Output 1 (-)	PO1 (-)	Black	
Drain	(Drain)	Bare Wire	—
Pulse Output 3 (+)	PO3 (+)	Red	Form B
Pulse Output 3 (-)	PO3 (-)	Green	

Table 2-Circular Connector

Output	Name	Connector Pin	Pulse Type
Drain	(Drain)	C	—
Pulse Output 2 (+)	PO2 (+)	D	Form A
Pulse Output 2 (-)	PO2 (-)	E	



NON HAZARDOUS AREA

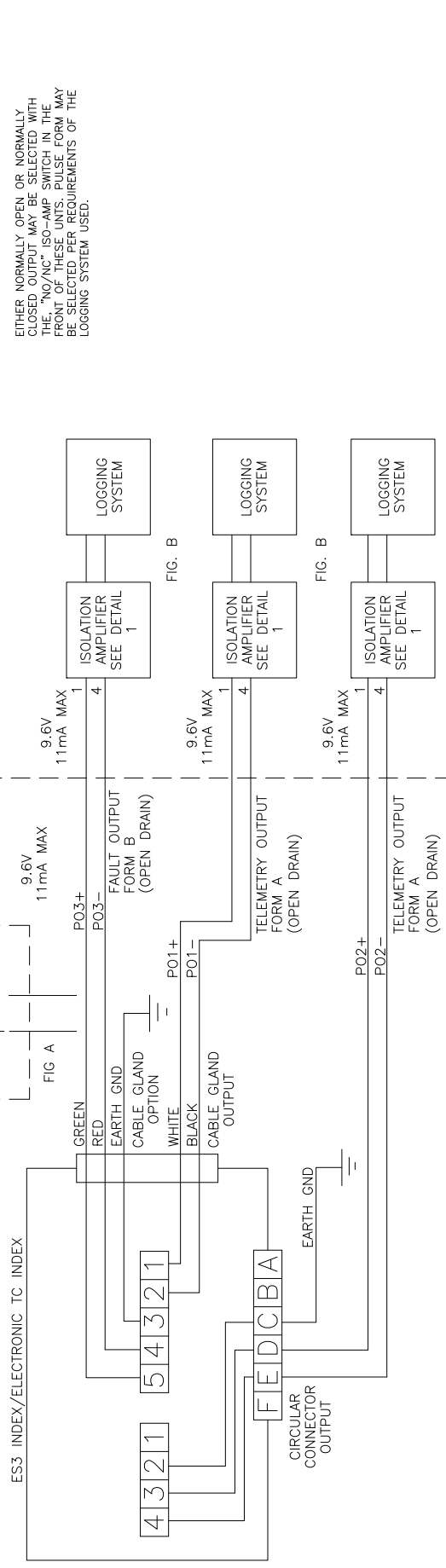
ALL INTRINSICALLY SAFE WIRING MUST BE SEPARATED FROM ANY OTHER SAFE ZONE WIRING BY AT LEAST 2 INCHES IN A SEPARATE PANDUIT.

USE TURCK IM1-12EX-T SINGLE CHANNEL, IM1-22 EX-R DUAL CHANNEL ISOLATION AMPLIFIERS OR EQUIVALENT WHICH ARE CAPABLE OF HIGH SPEED SWITCHING RESPONSE.

EITHER NORMALLY OPEN OR NORMALLY CLOSED OUTPUT MAY BE SELECTED WITH THE "NO/NC" ISO-AMP SWITCH IN THE FRONT OF THESE UNITS. PULSE FORM MAY BE SELECTED PER REQUIREMENTS OF THE LOGGING SYSTEM USED.

HAZARDOUS AREA  
(CLASS I, DIVISION 1, GROUPS A, B, C AND D)

EACH PULSE OUTPUT MAY BE CONNECTED INDEPENDENTLY TO EITHER ONE INTRINSICALLY SAFE DEVICE (FIG A) IN THE HAZARDOUS AREA OR, ONE DEVICE USING ISOLATION AMPLIFIER IN THE NONHAZARDOUS AREA. (FIG B)



GROUND CONNECTION USE EARTH GROUND WHEN ONLY INTRINSICALLY SAFE DEVICE IS CONNECTED TO TELEMETRY OUTPUT.

USE INTRINSIC SAFETY GROUND BUSES IN THE NON HAZARDOUS AREA IF USING EVEN ONE WIRELINE TELEMETRY CONNECTION.

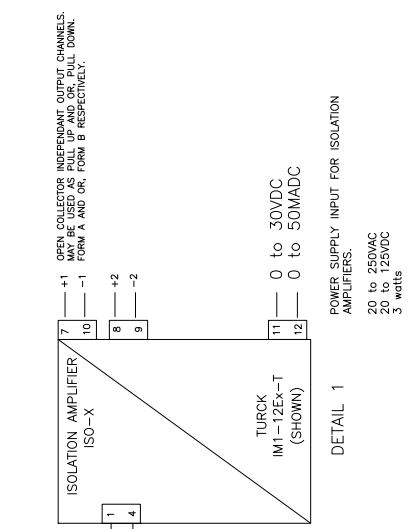
NEVER ATTACH BOTH GROUND CONNECTIONS.

MULTIPLE CONNECTIONS OF ANY ONE OUTPUT TO MORE THAN ONE DEVICE IS PROHIBITED.

NOTE PULSE OUTPUT SIGNAL POLARITY GOING TO ANY DVICE OR ISOLATION AMPLIFIER.

HAZARDOUS AREA INSTALLATIONS IN CANADA MUST BE INSTALLED IN ACCORDANCE WITH THE CANADIAN ELECTRICAL CODE (CEC) PART 1.

HAZARDOUS AREA INSTALLATIONS IN THE UNITED STATES MUST BE INSTALLED IN ACCORDANCE WITH THE NATIONAL ELECTRIC CODE (NEC).



**Figure 9.8-Wiring diagram for hazardous locations (AMR version-060794-000)**

## 9.4 Wiring the Itron Remote Gas Endpoint Device to the ETC

- A. Cut the cable and remove the vinyl, which will make for a cleaner and easier installation. Be sure not to damage the wires when removing vinyl cover. See Figures 9.9 and 9.10.

**Leave some cable available for any future changes to the AMR device.**

**Note:** You do not need to strip the wire as the Gel Cap splices supplied with the AMR are Insulation Displacing Connection (IDC) type connectors.

- C. Clip off the unused drain wire. Tuck all wires into the appropriate pocket in the back of the AMR. (Figure 9.13 & 9.14)

**Note:** Ensure the cable fits into an open pocket inside the ERT. The individual wires do not need to remain in a pocket since the walls of the pockets are lower than the outside walls of the housing and the mounting bracket has raised mounting points in the corners to prevent pinching of the individual wires.



Figure 9.9-Cut the AMR cable



Figure 9.10-Remove vinyl

- B. Use appropriate crimping pliers to seal and splice (Figure 9.11 & 9.12) wires per table.

ETC External Cable Wire	AMR Device Wire
Black	Red
Green	Blue
White & Red	White

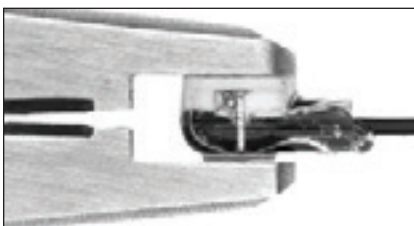


Figure 9.11-Seal wire

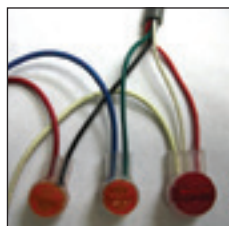


Figure 9.12-Splice wire

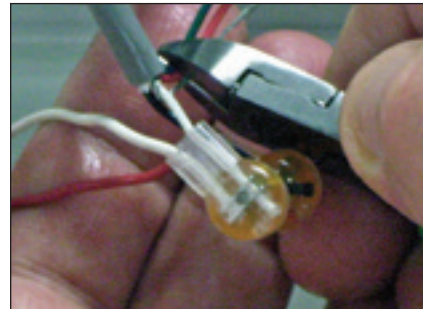


Figure 9.13-Clip unused wires

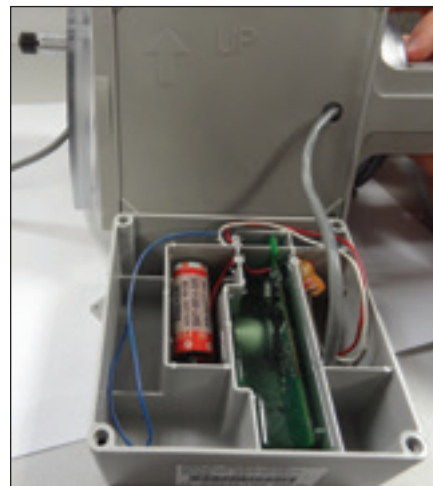


Figure 9.14-Tuck extra cable into a pocket

- D. Use a T15 Torx screwdriver to attach the AMR to the ETC AMR bracket. See Figure 9.15.

## 9.5. Confirm Itron Remote Gas Endpoint Device is Properly Mounted

**Important:** Regardless of AMR model or meter orientation (side or top inlet) the bar code on the side of the AMR device must always face up, as shown in Figure 9.15. This puts the tilt/tamper switch in the proper orientation in the AMR.



**Figure 9.15**-Bar code faces up

- A. For side inlet, the AMR bracket is on top (or 90°) from the odometer, as shown in Figure 9.16.
- B. For top inlet, the AMR bracket is directly opposite the odometer, as shown in Figure 9.17.



**Figure 9.16**-Side inlet: notice the close positioning of the ETC label to the bracket



**Figure 9.17**-Top inlet: notice the space between the ETC label and the bracket

## 10. Operation Mode

Dresser MeterWare is the software on your computer that connects your computer to the ETC index. The software provides the capability to configure the ETC, as well as download logged data and update the ETC firmware. An infrared cable using the IrDA protocol connects the MeterWare to the ETC.

Once MeterWare is connected to the ETC, a Live Data screen displays current operating conditions. The Volume Configuration screen provides the ability to adjust volume information, such as odometer readings and pulse output configurations. Also, Faults and Alarms are configurable and the screens that are displayed on the ETC Liquid Crystal Display (LCD) are selectable.

For detailed information on the installation and operation of the MeterWare user terminal interface, consult the MeterWare User Manual.

### 10.1 Volume Measurement

1. Imperial or metric measurement options

The measurement unit displayed through the LCD screen display is set through the Dresser MeterWare software.

Configurable items:

- Volumetric units
- Temperature (Fahrenheit or Celsius)
- Fixed Factor Pressure (PSI or kPa)

## 2. Volume detection

Volume from the meter to the ETC accessory unit is detected via a volume input board. This volume input board utilizes the same Wiegand sensor technology used in the Dresser solid-state pulsers and the magnetic pickups used to detect volume on the Dresser Integral Micro Correctors, Model IMC/W2.

There are five volume accumulation methods based on the capability to read either the forward or reverse flow directions. The five volume accumulation methods are shown in Table 1 below.

**Table 1**-Volume Accumulation Methods

Volume Accumulation	Measured Flow Source		
	Forward	Reverse	Calculated Flow
Forward minus (-) Reverse	✓	✓	Volume in Reverse flow is subtracted from the volume calculated in Forward flow.
Reverse minus (-) Forward	✓	✓	Volume in Forward flow is subtracted from the volume calculated in Reverse flow.
Reverse	X	✓	Volume in Reverse flow only is calculated. All flow in the Forward direction is ignored.
Forward	✓	X	Volume in Forward flow only is calculated. All flow in Reverse direction is ignored
Forward plus (+) Reverse	✓	✓	Volume in Reverse and Forward flow are calculated. Calculated volume is the total of all flow in both directions.

**Note:** The factory default method for volume accumulation is Forward minus Reverse. Refer to the MeterWare manual to change the accumulation method.

## 3. Volume Sample Frequency

Volume is sampled every 30 seconds.

## 4. Volume Update Frequency

All parameters on the LCD are updated every 30 seconds.

## 5. Pulse Outputs in real time

Volume pulses are provided in real time. The Form A outputs are configurable by:

- Volume per pulse
- Pulse width
- Imperial or metric

The Form B fault/alarm pulse output is not configurable and provides a 500 ms pulse every 30 seconds when a fault or alarm is present.

## 10.2 Temperature Measurement

Temperature is measured using a Class A, PT1000 precision RTD and is sampled every 30 seconds. In normal operation, the accumulated temperature Corrected Volume total is updated every 30 seconds and is displayed in standard cubic feet (SCF) or normal cubic meters (nm<sup>3</sup>) over the temperature measurement range of -40°F to + 140°F (-40°C to +60°C).

The total ambient temperature effect is less than 0.1°F (0.05°C) over the entire temperature range. Additionally, temperature measurement accuracy is graduated over the measurement range as shown in Table 2.

**Table 2**-Temperature Reading Accuracy

Temperature Reading Accuracy	
-40°F to 140°F: +/- 0.9°F	(-40°C to 60°C: +/- 0.5°C)

The units of measure (°F or °C) and the reference base temperature are configurable using the Dresser MeterWare software.

**Note:** The default base temperature is 60°F for imperial applications and 15°C for metric applications.

For ease of calibration, there is a provision in the Dresser MeterWare software to perform a single point temperature field calibration. Consult the MeterWare manual for details.

## 10.3 Flow Rate

Flow rate is accessed by scrolling to Flow Rate screen on the ETC display screen as described in Section 7.

The flow rate for the ETC is an average value based on the last 30 seconds of stored uncorrected volume data. Since the data collected by the ETC is updated and stored every 30 seconds, there is always a slight delay in the timing of the displayed results ranging anywhere from 1 to 29 seconds until the results are updated again.

When the gas flow is fairly steady, the flow rate information is accurate. However, when the flow rate is shifting, there is a notable amount of error calculated by the ETC depending directly on how rapidly and how much the gas flow is actually changing. As long as the flow through the meter set is fairly steady, the flow rate provided by the ETC is valid for testing the differential pressure across the meter.

In summary, the flow rate indication is recent (but not instantaneous) and is based on the average flow rate of the last 30 seconds of saved information.

## 10.4 Faults and Alarms

### 1. Faults

A Fault is a problem with the ETC accessory unit hardware.

Fault types:

- Temperature—when the temperature probe is faulty or disconnected from the ETC unit.
- Volume—when the volume input board has a problem such as a bad sensor.
- Volume Sensor — An open wire on the volume input board or mag pickup is present.
- Internal operations—when an issue occurs with the electronic hardware or the microprocessor. This also may occur when memory access fails.
- Power Fault — A power problem occurred or battery wiring is disconnected.
- Low Battery—when the battery voltage drops below 2.7 V.

### 2. Alarms

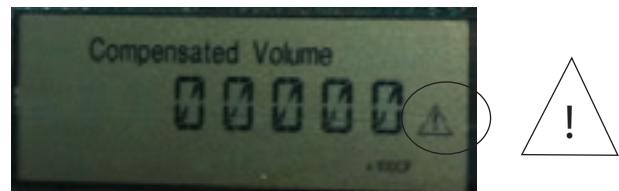
Alarms inform the user when a measurement reading exceeds operator configurable limits.

Alarm Types:

- High Temperature Alarm Limit—when temperature goes above the user defined limit.
- Low Temperature Alarm Limit—when temperature drops below the user defined limit.
- High Flow Rate Alarm Limit—when flow rate goes above the user defined limit. Default high flow alarm allows for a 20% overspeed (not user configured).
- Low Battery Alarm—when battery voltage drops below 3.0 V. (not user configured).

### 3. LCD display notices

When a Fault or Alarm is active, the LCD display will show a caution symbol as shown in Figure 10.1.



**Figure 10.1**-Fault/Alarm symbol as displayed on LCD Screen

Scroll through the LCD displays, using the magnet provided in the Communication Kit, until the relevant Fault or Alarm is displayed. Faults and Alarms are displayed on the LCD screen as listed in Table 3.



**10.4.1-Fault Types** A fault indicates a problem with the electronics hardware or firmware.

Fault type	LCD Screen Display	Occurs When
Temperature Fault	T FLT	The temperature probe is faulty or disconnected from the meter electronics.
Volume Fault	VOL FLT	The volume input pulses are out of sequence.
Volume Sensor Fault	VOL SNSR FLT	An open wire on the volume input board or mag pickup is present.
Internal Operation Fault	INT FLT	A memory access fault is present.
Power Fault	PWR FLT	A power problem occurred or battery wiring is disconnected.
Low Battery Fault	LOW BATT	The battery voltage drops below 2.7 V.

**10.4.2-Alarm Types** An alarm indicates when a battery has low voltage or when line temperature or flow rate has moved above or below the desired limits.

Alarm type	LCD Screen Display	Occurs When
High Temperature Alarm Limit	HIGHT. AL.	The temperature rises above the user-defined limit.
Low Temperature Alarm Limit	LOWT. AL.	The temperature drops below the user-defined limit.
High Flow Rate Alarm Limit	HIGHFL. AL.	The flow rate rises above the user-defined limit.  Note: Default high flow alarm allows for a 20% overspeed.
Low Battery Alarm	LBATT AL.	The battery voltage drops below 3.0 V (not user configurable).

**4. MeterWare Notices:**

Faults and alarms are also listed on the Live Data screen in the Dresser MeterWare software as shown in Figure 10.2 and Figure 10.3. When a Fault or Alarm is present, the value is highlighted in red.

In order to clear existing Alarms and Faults, connect the ETC to the Dresser MeterWare software and clear the items in the “Faults and Alarm” tab as shown in Figure 10.4. For more information on these features, refer to the MeterWare Manual.

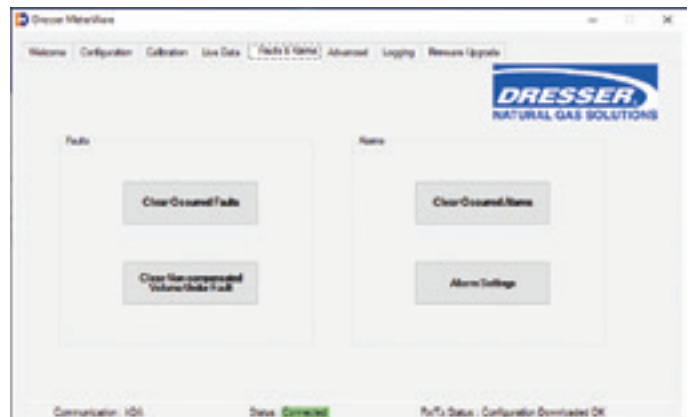
In order to clear faults and alarms without using the MeterWare software, use the magnet to scroll to the LCD TEST value screen and after 20 seconds the FLT AL screen will appear. Hold the magnet on the word “Swipe” for at least 6-10 seconds and this will clear the **occurred faults** and **occurred alarms**<sup>1</sup>.



**Figure 10.2**-Live Data Screen showing Faults in Dresser MeterWare Software



**Figure 10.3**-Live Data Screen showing Alarms in Dresser MeterWare Software



**Figure 10.4**-Faults and Alarms Screen as displayed in Dresser MeterWare Software

**Note:** If a battery fault is present, the battery must be disconnected and reconnected (or replaced) to eliminate the fault. If the battery is replaced be sure to reset the battery life clock. Refer to Section 11.1 for complete instructions on accessing and replacing the battery.

<sup>1</sup> Please note this will not clear present faults or present alarms as these will remain active until the fault or alarm is resolved.

## 5. Fault and Alarm Pulse Outputs

The ETC is capable of providing a pulse output when a Fault or Alarm is present. This feature is configurable in the Volume Configuration screen of Dresser MeterWare. (The Volume Configuration screen is reached by selecting the "Configuration" tab in MeterWare and then selecting the "Volume" box.)

Pulse Output 1 and Pulse Output 2 provide a Form A (Normally Open) pulse when "Fault" is selected for the output. A pulse output is provided every 30 seconds when a Fault or Alarm is present. The pulse width is selectable as 50, 150, or 250 ms.

The AMR Version of the ETC also provides the capability for a third pulse output (Pulse Output 3). There are only two settings for the pulse output, either "Disabled" or "Fault". No pulses are provided when disabled, but when the "Fault" feature is selected a pulse is provided once every 30 seconds whenever a Fault or Alarm is present. Unlike the other two pulse outputs, Pulse Output 3 is a dedicated Form B (Normally Closed) switch and is configured for a 500 ms pulse.

When a fault of any kind is present in the ETC:

- The pulse outputs for Compensated and/or Non-Compensated volume will not pulse out.
- Any pulse output configured to be a Fault pulse will function as an alarm/fault pulse output.
- All pulse outputs will continue to perform as configured, if an alarm is present.

If the ETC is configured to utilize the "Fixed Temperature Under Fault" function to correct when the unit has a Temperature Fault, then the Compensated and Non-Compensated Volumes:

- Continue to increment and be displayed on the LCD;
- Are logged in the Logged Data Reports.

If the ETC is not configured to utilize the "Fixed Temperature Under Fault" function and a Temperature Fault occurs, then the Non-Compensated volume only continues to be logged in the "Non-Compensated Volume Under Fault" register, and will be displayed as the same on the LCD, if that parameter is enabled at time of unit configuration.

## 10.5 Logging

### 10.5.1. Data Log

Data logs are recorded hourly. The ETC maintains 150 days of hourly logs on a first in first out (FIFO) basis. The Data Logging feature is not configurable.

The user can decide how many days of hourly logs to download using the Dresser MeterWare software.

### 10.5.2. Logged Parameters

The ETC has non-volatile memory. If the unit experiences battery failure, all logs obtained within the last hour of operation are retained and are available and ready for use as soon as power is restored. In addition, the configuration is stored in non-volatile memory and is not lost in the event of main battery failure.

Data logs (order dependent) are continually stored in the memory on an hourly basis consisting of these 26 parameters:

- Log Number
- Log Date & Time
- Compensated volume
- Non-compensated volume
- Compensation factor
- Non-compensated volume under fault
- End temperature
- Battery voltage
- Present fault – temperature
- Present fault – volume
- Present fault – internal operation
- Present fault – low battery
- Occurred fault – temperature
- Occurred fault – volume
- Occurred fault – internal operation
- Occurred fault – low battery
- Present alarm – high temperature
- Present alarm – low temperature
- Present alarm – high flow
- Present alarm – low battery
- Present alarm-volume input
- Occurred alarm – high temperature
- Occurred alarm – low temperature
- Occurred alarm – high flow
- Occurred alarm – low battery
- Occurred alarm-volume input

### 10.5.3. Audit Log

The audit log includes a tracking facility that details parameter changes that affect billing. This log maintains the most recent change and the original information. Historical changes beyond the most recent change are not retrievable. The audit log cannot be deleted. Changes are recorded in the audit log, can include:

- Parameter changed
- Date and time the change occurred
- Old value
- New value

Parameters captured in the audit log are:

- Meter type
- Meter size
- Revolution/Unit volume
- Flow sense
- Temperature units
- Base temperature
- Temperature model
- Fixed temperature
- Pressure units
- Base pressure
- Atmospheric pressure
- Pressure factor
- Fixed pressure
- Pressure mode
- Compensated multiplier
- Non-compensated multiplier
- Pulse output 1
- Pulse output 2
- Pulse output 3
- Pulse output 1 selected
- Pulse output 2 selected
- Pulse output 3 selected
- Telemetry form A pulse width
- Compensated volume
- Non-compensated volume
- Non-compensated volume under fault
- Pressure calculation type
- User temperature calibration offset
- High temperature alarm limit
- Low temperature alarm limit

Both the data logs and the audit log are saved as a CSV (comma-delimited) file to expedite easy import into spreadsheets such as MS Excel™.

## 11. Maintenance

### 11.1 Battery Replacement

The electronics are powered by a battery pack consisting of two Lithium Thionyl Chloride batteries having an average normal life of 20-years. The actual length of the battery life will depend upon the conditions of use. Battery life is calculated assuming continuous flow at 50% of the meter's maximum capacity. Temperature affects battery life. As an example, battery life expectancy for cooler climates such as Minneapolis, MN, are calculated at 20+ years, while warmer climates such as Las Vegas, NV, have a calculated battery life of 15+ years.

The state of the battery pack is monitored and the ETC unit generates either a low battery alarm or fault before the batteries are discharged. A low battery **alarm** is generated when the battery pack voltage drops below 3 volts and an alarm icon in the form of a triangle is generated on the LCD of the unit. A low battery **fault** is generated when the battery pack voltage drops below 2.7 Volts and a "CHANGE BATT" message appears on the LCD of the unit. The period of time between the Low Battery Alarm and the Low Battery Fault is approximately 90 days.



### 11.1.1 Changing the battery on Series B and Series A Meters – Circular Pulse Output Connector Version:

A. **Important:** Using the battery change function (BATT.CHNG) will create a data log, which will ensure that you do not lose any data during the battery change. **This will also reset the battery life clock.**

1. Use a magnet to scroll (refer to Section 7) through the LCD screens to the **BATT.CHNG** screen.

**Note:** do not pass the BATT.CHNG screen, as the data will not save. If you do pass the screen, be sure to come back to this screen and leave it displayed. This action forces a data save and creates a log.

2. When the screen automatically returns to the default screen (either **Compensated Volume** or **Non-Compensated Volume**, depending on customer configuration), the log has been created, and you can proceed with the battery change.

**Note:** The same instructions in Section A (1-2) apply to changing the battery in the **ETC AMR version**.

B. To remove the existing battery:

1. Using a 9/64-inch hex wrench, remove the four hex-head screws on the **end cap** of the ETC unit cover; save screws for reinstallation of the end cap.
2. Pull the end cap straight out, away from the unit, extending only far enough to access the connected wires.
3. Squeeze to release the black connector (circled in Figure 11.1), from the mating connector.

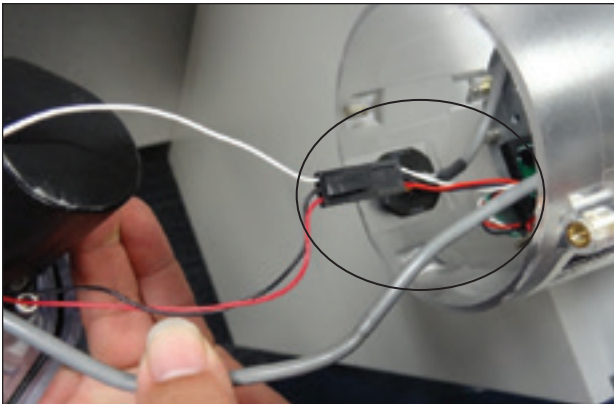


Figure 11.1-Squeeze to release cord

4. Using a 9/64-inch hex wrench, remove the three screws holding the battery in place on the lid of the end cap; save these screws for later use.

C. To install the new battery:

1. Insert three saved screws in battery bracket openings.
2. Align the battery with the screw holes on the end cap  
**Note:** there is only one way in which the battery can be installed.
3. Using a torque wrench with a 9/64-inch hex adapter, work in a cross pattern to tighten the three screws to **6-7 inch pounds**.
4. Ensure the gray wire is against the wall of the cover as shown in Figure 11.2.

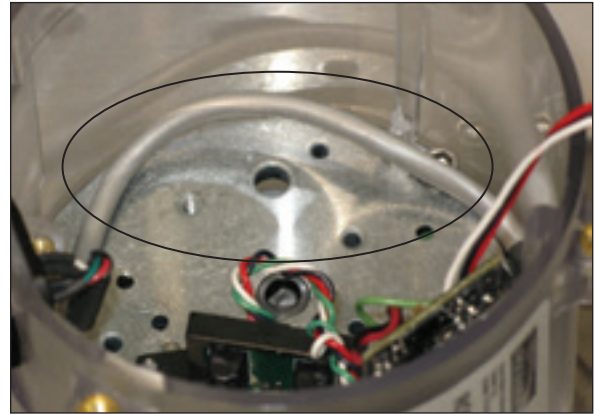


Figure 11.2-Gray wire against wall of the cover

5. Take excess slack out of the battery wires by threading through the center of the two battery stacks and gently wrapping the wires around the stacks as shown in Figure 11.3.



Figure 11.3-Remove excess slack: circular version

6. Squeeze the black connector while sliding it into the mating connector.  
**Note:** The connectors are keyed and will only fit together in one orientation.
7. Align the flat side of the end cap with the flat side of the ETC cover.
8. Working in a cross pattern, tighten the four exterior screws to 6 – 7-inch pounds using a torque wrench.

**Important:** Dispose of the expired battery according to your company's standards or to RoHS (Restriction of Hazardous Substances) compliance standards.

### 11.1.2 Changing the Battery on Series B and Series A Meters – AMR Version

A. **Important:** Using the battery change function (BATT.CHNG) will create a data log, which will insure that you do not lose any data during the battery change. **This will also reset the battery life clock.**

1. Use a magnet to scroll (refer to Section 7) through the LCD screens to the BATT.CHNG screen.

**Note:** do not pass the **BATT.CHNG** screen, as the data will not save. If you do pass the screen, be sure to come back to this screen and leave it displayed. This action forces a data save and creates a log.

2. When the screen automatically returns to the default screen (either **Compensated Volume** or **Non-Compensated Volume**, depending on customer configuration), the log has been created, and you can proceed with the battery change.

B. To remove the existing battery in AMR version:

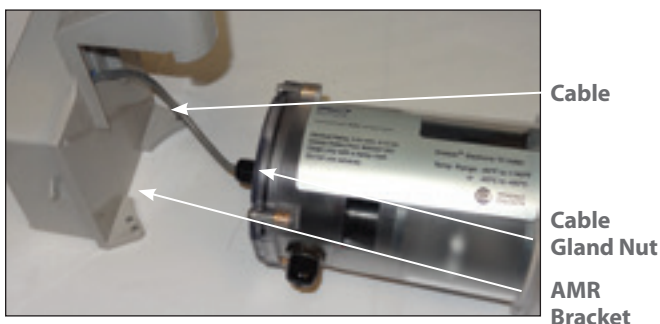
1. Using a 5/32 Allen wrench, remove the two (2) 5/32 screws that attach the AMR bracket to the ETC as shown in Figure 11.4.

**AMR bracket & (2) 5/32 screws (one screw not shown)**



**Figure 11.4-**Remove two screws attaching AMR bracket to ETC

2. Carefully remove the AMR bracket from the ETC. **Note:** Do not open AMR or cut the cable that is wired from the ETC to the AMR. Refer to Figure 11.5 below.

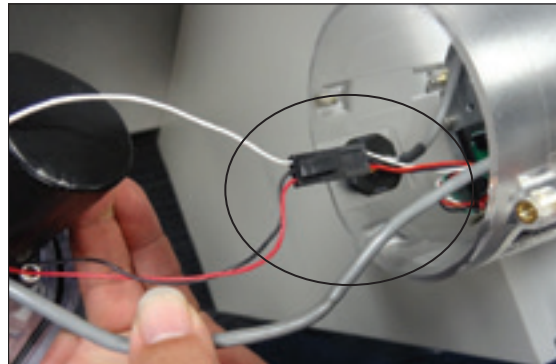


**Figure 11.5-**Remove AMR bracket from ETC

3. Loosen the nut on the Cable Gland shown in Figure 11.5.

**Note:** The Cable Gland nut does not need to be removed.

4. Using a 9/64-inch hex wrench, remove the four hex-head screws on the end cap of the ETC unit cover; save screws for re-installation of the end cap.
5. Pull the end cap straight out, away from the unit, extending only far enough to access the connected wires.
6. Squeeze to release the black connector (circled in Figure 11.6), from the mating connector.

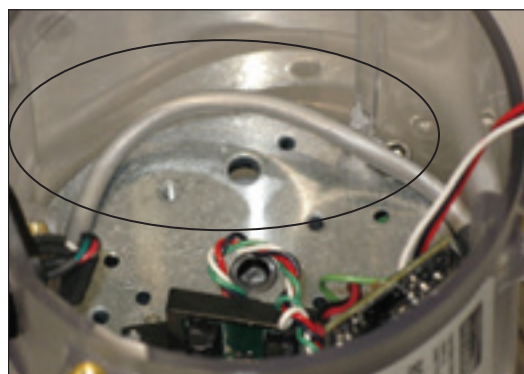


**Figure 11.6-**Squeeze to release cord

7. Using a 9/64-inch hex wrench, remove the three (3) screws holding the battery in place on the lid of the end cap; save these screws for later use.

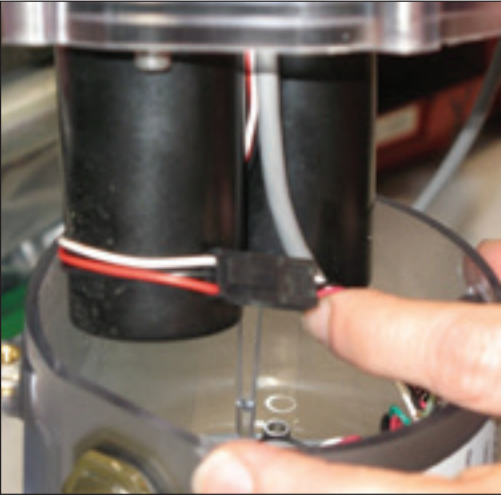
C. To install the new battery:

1. Insert three saved screws in battery bracket openings.
  2. Align the battery with the screw holes on the end cap.
- Note:** there is only one way in which the battery can be installed.
3. Using a 9/64-inch hex wrench, work in a cross pattern to tighten the three screws to **6 – 7 inch pounds** using a torque wrench.
  4. Ensure the gray wire is against the wall of the cover as shown in Figure 11.7.



**Figure 11.7-**Gray wire against wall of the cover

- Take excess slack out of the battery wires by threading through the center of the two battery stacks and gently wrapping the wires around the stacks as shown in Figure 11.8.



**Figure 11.8**-Remove excess slack: AMR version

- Squeeze the black connector while sliding it into the mating connector.
- Note:** The connectors are keyed and will only fit together in one orientation.
- Align the flat side of the end cap with the flat side of the ETC cover.
  - Working in a cross pattern, tighten the four exterior screws to **6 – 7 inch pounds** using a torque wrench.
  - Torque the cable gland nut to **15-inch pounds** on the end cap before installing the AMR bracket to the ETC.

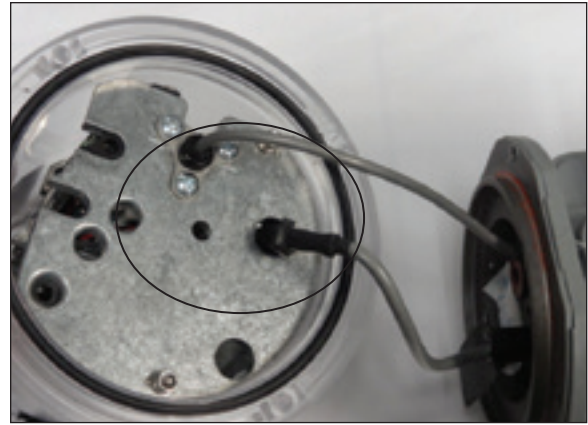
**Important:** Dispose of the expired battery according to your company's standards or to RoHS (Restriction of Hazardous Substances) compliance standards.

## 11.2 Temperature Probe Replacement for Series B and Series A Meters

- Remove the ETC from the meter body. Refer to Section 8 for complete directions.
- Temperature probe removal:

**Note:** These instructions apply for both Circular Connector and AMR Versions.

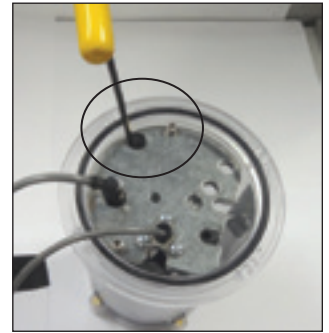
- Once you have carefully pulled the ETC from the meter body, remove the black grommet that secures the probe in its place (Figure 11.9).
- Using a Phillips-head screwdriver, remove the three screws holding the plate around the temperature probe (Figure 11.9); save the screws and plate for replacement.



**Figure 11.9**-Remove grommet securing previous probe; remove plate for probe

- Using a 9/64-inch hex wrench, and inserting through the indicated hole (see Figure 11.10), remove the single screw that holds the counter to the unit; save the screw for replacement.

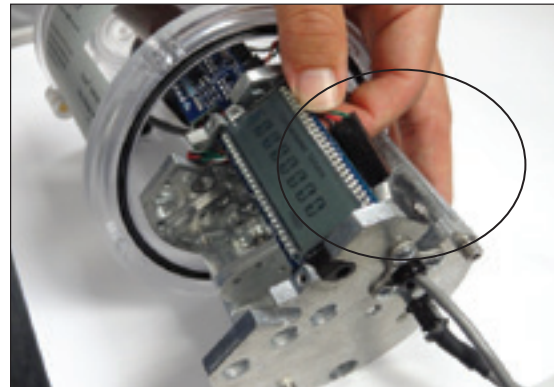
- Gently remove the electronic mounting platform from the clear housing cover far enough that you can access the connection that holds the wire from the probe to the wire for the unit.



**Figure 11.10**-Remove single screw holding counter to unit

**Important:** Slide the electronic mounting platform from the housing until you feel resistance. Do not pull beyond this point. Pulling to hard can damage the electronics.

- Squeeze the connecting end of the wires (as circled in Figure 11.11) to release the cord from the receiving end.



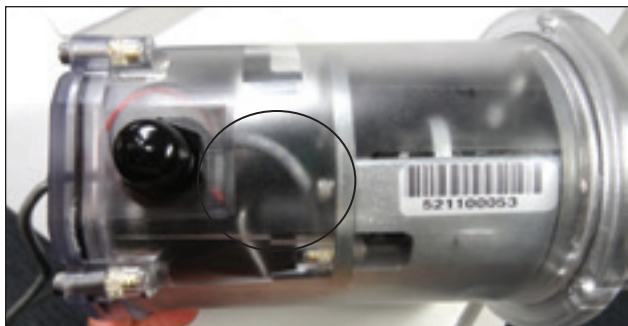
**Figure 11.11**-Squeeze connector to release and make the wire connection.



### C. Insert new temperature probe

1. Using the wire from the replacement temperature probe, squeeze the receiving end of the wire and slide the connecting end into place. (Refer to Figure 11.11)
2. Replace the electronic mounting platform into the clear housing, making sure to align the screw hole and the screw.

**Important:** Ensure the insulated gray wire from the counter unit is not pinched between the counter and the housing unit in Figure 11.12



**Figure 11.12**-Ensure the insulated gray wire is not pinched

3. Using a torque wrench with a 9/64-inch hex adapter, tighten the single screw that holds the counter to the unit to **6 – 7 inch** pounds.
4. Replace the plate over the temperature probe.
5. Using a torque wrench with a Phillips-head screw adapter and working in a cross pattern, replace the three screws holding the plate around the temperature probe; tighten to **8-inch** pounds.
6. Return the grommet to its place above the black part of the probe by encircling the cable; use needle-nose pliers to compress the grommet until it reseats in the hole.
7. Push gently with fingers, and the grommet will snap into place.

**Important:** Prior to returning the ETC to service, the temperature probe requires calibration. Refer to the MeterWare manual for the procedure to perform a single point calibration of the temperature probe.

This procedure requires a stable and accurate temperature reference device for comparison. Allow enough time for the temperature to stabilize between the new probe and the reference temperature device. For the best results, submerge the new temperature probe and the reference temperature probe in a temperature controlled liquid bath.

### D. Re-attach accessory unit to the meter body

Refer to section 8.2.1 for assembling circular connector version ETC index to the meter body.

Refer to section 8.2.2 for assembling AMR version ETC index to the meter body.

## 11.3 Cleaning, Chemicals List

**Important:** No oil is required for the ETC accessory unit.

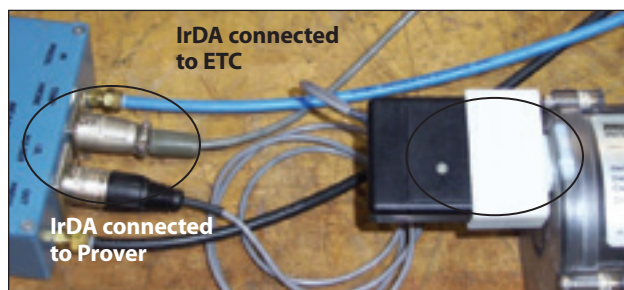
To clean the clear housing cover, use hot water and soap, mineral spirits, Isopropyl alcohol or cleaning products approved for use on the cover.

**Important:** Aromatics, Ketones and chlorinated hydrocarbons will damage the accessory unit cover. Do not use acetone, carbon tetrachloride, etc.

## 12. Proving the ETC with Dresser Model 5 Transfer Prover

### 12.1 Establish IrDA Cable Connection

- A. Insert the IrDA adapter in the cover of the ETC as shown in Figure 12.1.
- B. Attach the cable connector of the IrDA to the ID Pulser connection port on the Prover field meter junction box, as shown in Figure 12.1.
- C. Turn on the power switch of the Model 5 Prover, and wait for light on the IrDA to come on and start flashing.
- D. Once the ETC unit is put into "Prove Mode," the flashing light changes to a solid light, as shown in Figure 12.2.



**Figure 12.1**-Connect IrDA to ETC and Model 5 Prover



**Figure 12.2**-Light indicating connections is established

## 12.2 Set Prove Mode on the ETC

This section details how to configure the ETC to go into the prover test mode. If you are able to scroll to a screen stating "PROV C.V" (for compensated testing) or to "PROV NC.V" (for non-compensated testing) the ETC is already configured for prover testing.

If the ETC is already configured for testing, go to Section 12.3 for testing compensated volumes or to Section 12.4 for testing non-compensated volumes.

- A. Using the Dresser MeterWare software go to the **Configuration** screen (Figure 12.3), and click **Customize LCD**, which will open the **LCD Settings** screen.

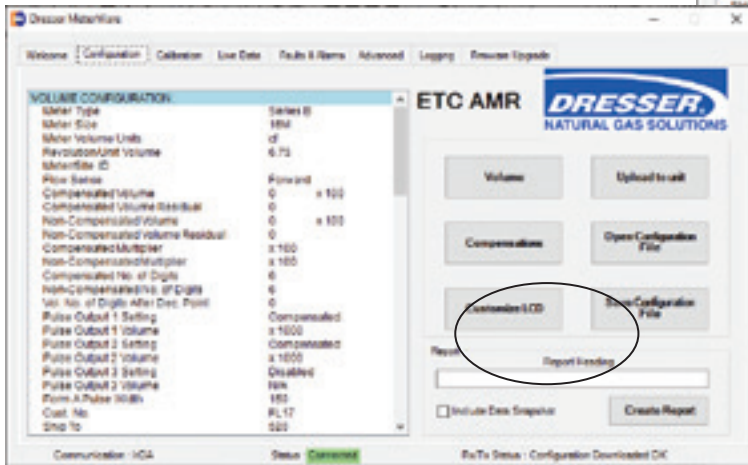


Figure 12.3-Configuration screen in Dresser MeterWare

- B. From the **LCD Settings** screen (Figure 12.4), choose either **Compensated Prove Mode** or **Non Compensated Prove Mode**, or both, and then click **OK** to return to the **Configuration** screen.

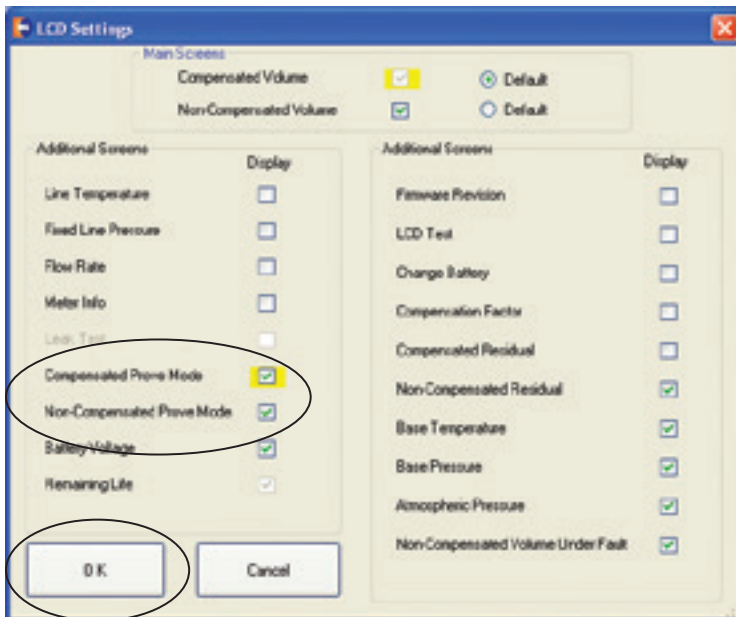


Figure 12.4-LCD Settings screen in Dresser MeterWare

- C. Once back on the **Configuration** screen (Figure 12.5), click **Upload to unit**.

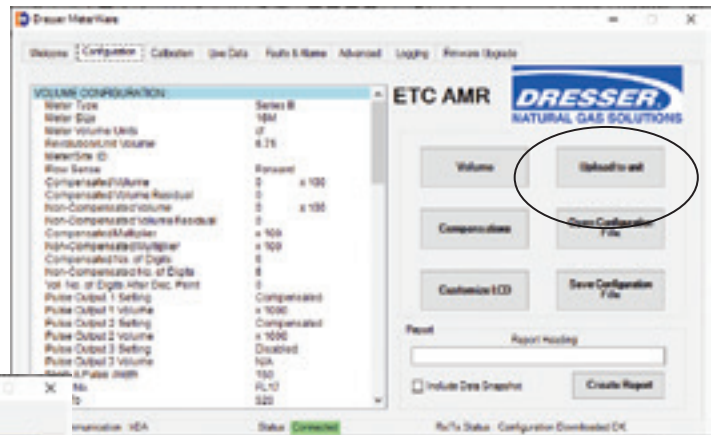


Figure 12.5-Configuration screen in Dresser MeterWare

- D. The chosen prove mode can then be selected on the LCD screen display of the ETC.

## 12.3. Prove Compensated Volume

- A. Swipe the magnet across the "Swipe" line on the label until the screen displays **PROV C.V** (Figure 12.6), and then stop swiping.



Figure 12.6-LCD screen displays PROV C.V

- B. After five (5) seconds, the display will change to **PROVE I.C.V** (Figure 12.7).



Figure 12.7-LCD screen displays PROVE I.C.V

- C. Hold the magnet for about five (5) seconds on the word "SWIPE" until the display changes to **PRVE\_CO.R** (Figure 12.8).  
The ETC is now ready to be proved using the compensated volume output.

- C. Hold the magnet for about five seconds on the word "SWIPE" next to the LCD screen display until the display changes to **PRVE\_NC.V** (Figure 12.11).  
The ETC is now ready to be proved using the non-compensated volume output.

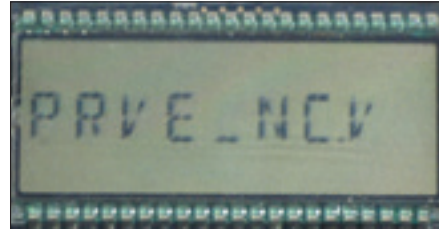


Figure 12.8-LCD screen displays **PRVE\_CO.R**

Figure 12.11-LCD screen changes to **PRVE\_NC.V**

- D. Exit Prove Mode by holding the magnet on the word "SWIPE" for five (5) seconds.

- D. Exit Prove Mode by holding the magnet on the word "SWIPE" on the LCD screen display for five (5) seconds.

### 12.4 Prove Non-Compensated Volume

- A. Swipe the magnet across the "Swipe" line on the label until the screen displays **PROV NC.V** (Figure 12.9), and then stop swiping.

### 12.5 Model 5 Prover Software Configuration

The Model 5 Prover software must be set up as circled on the left side of the screen shot as shown in Figure 12.12. The TC options box must also be set for **Diaphragm TC** for all meter sizes, as circled in Figure 12.12. For reference, the values for the prover configuration are explained in Section 12.6.

NOTE: The recommended pulses per test and test volume are shown in Table 12.13 according to meter size. Using the shown values will allow for a test lasting a minimum of the factory recommended 30 seconds.

Click **Start** and the prover test will begin to run.



Figure 12.9-LCD screen displays **PROV NC.V**

- B. After five seconds, the display will change to **PROVE I.U.V** (Figure 12.10).



Figure 12.10-LCD screen changes to **PROVE I.U.V**

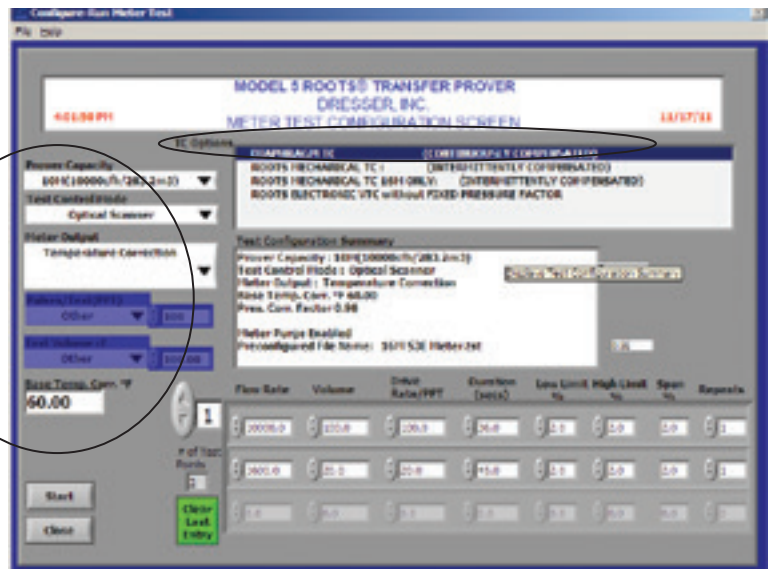


Figure 12.12-Prover Configurations screen for Model 5 Prover software



**Figure 12.13**-Recommended prover configuration settings based on meter size

Meter Size	Flow Rate (% of Maximum Flow Rate)			
	100%		10%	
	Min. # of Pulses	Min Test Volume	Min. # of Pulses	Min. Test Volume
8C	8	8	4	4
11C	10	10	4	4
15C	15	15	5	5
2M	20	20	5	5
3M	30	30	5	5
5M	50	50	10	10
7M	70	70	15	15
11M	20	200	5	50
16M	20	200	5	50

## 12.6 Explanation of Prover Configuration Screen

### 12.6.1 Left Side of Prover Configuration Screen:

- Prover Capacity: Select "10M (10,000cfh/283.2 m<sup>3</sup>)" for flow rates above 100 cfh. For flow rates between under 35 cfh and 100 cfh, select the "2M (2,300cfh/65.1 m<sup>3</sup>)" master meter if the prover is equipped with this option. This will allow for testing an 8C meter at 10% capacity (80 CFH)
- Test Control Mode: Select "Optical Scanner"
- Meter Output: Select "Temperature Correction"
- Pulses/Test (PPT): Select "Other". Also select the pulses per test based on Table 12.13. This information is entered in the small box attached to the right of the "Pulses/Test" box.  
**Note:** Figure 12.12 is showing "100" pulses based on the configuration for a 16M meter at a 100% flow rate.
- Test Volume cf: Select "Other". In the small box on the right, enter the same number as the value input in the "Pulses/Test (PPT)". This is necessary since one pulse = 1 cf.

### 12.6.2 Top Right side of Prover Configuration Screen:

- TC Options: Select "Diaphragm TC (Continuously Compensated)

### 12.6.3 Bottom Portion of Prover Configuration Screen:

- Flow Rate: Enter the desired flow rate for the first test. Since the meter configuration shown in Figure 12.12 is for the 16M meter, the flow rate selected is 10,000 since this is the maximum capacity of the 10M master meter.

**Note:** The "Volume" and "Drive Rate/PPT" and other boxes will automatically populate based on the information provided on the left side for the Prover Configuration Screen.

### 12.6.4 Adding Additional Test Points:

- Flow Rate—To add additional test points, enter the desired flow rate in the next available box in the "Flow Rate" column. Figure 12.12 shows a value of "1600" representing 10% of flow for a 16M meter.
- Volume—Enter the desired test volume. Suggested values are provided in Table 12.13. A value of "20" is shown in Figure 12.12 representing the recommended test volume for testing a 16M meter at 10% of maximum flow rate.
- Drive Rate/PPT—As stated previously, the drive rate will always match the volume.
- The remaining boxes in the row will auto populate based on the current prover default settings.
- Start this process again to continue adding additional test points. Always start with the highest flow rate and progress downward to the lowest flow rate.

**Important:** When entering values, always move to the next box by either pressing "Enter" or using the cursor. Using "Tab" will cause errors in the test configuration.

**Note:** Contact factory to request pre-configured test files if preferred.

## 13. Upgrading the Firmware in the ETC

Using the Dresser MeterWare software and the IrDA cable assembly, which is part of the communications kit, you have the option to upgrade current firmware revision to newer revision levels. The installation of new firmware takes approximately two minutes.

**IMPORTANT:** The IrDA cable assembly must be held firmly in place when attempting to upgrade firmware revision levels. If the upgrade is interrupted while in process, the firmware in the unit will be corrupted, and the unit will need to be returned to the factory for reprogramming.

### 13.1 Attach IrDA cable

Refer to Figure 13.1 for the proper attachment of the IrDA cable to the ETC.

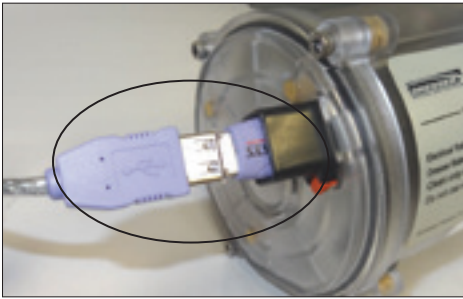


Figure 13.1-Proper installation of IrDa cable in ETC accessory unit

### 13.2 Establish Communication for Firmware Upgrade

A. From the Welcome screen in the MeterWare software, select the **Firmware Upgrade** tab. Refer to Figure 13.2.

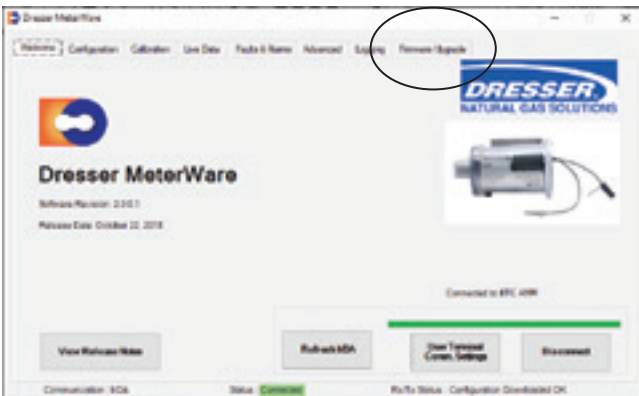


Figure 13.2-Firmware Upgrade Tab

B. From the next screen, click **Select File**. (Figure 13.3)

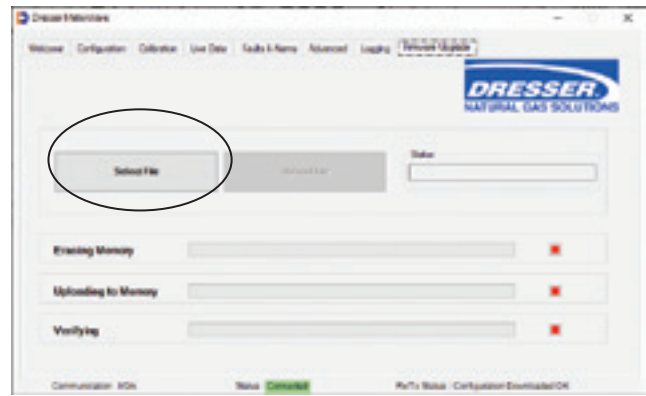


Figure 13.3-Firmware Upgrade Screen

C. From the **Open** screen, select the appropriate firmware upgrade file ending in ".hex," which in this example is "SW-0294-U3-1.67a.hex." Refer to Figure 13.4.

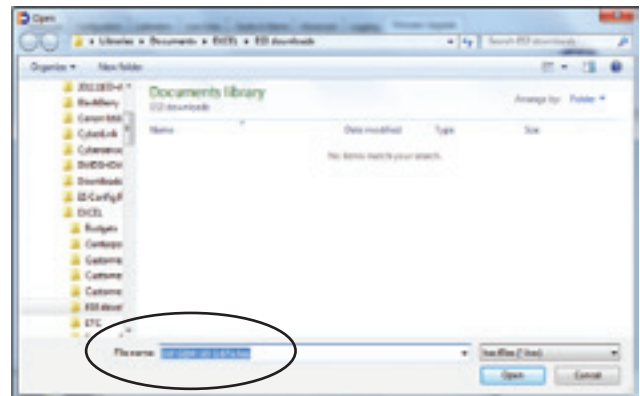


Figure 13.4-Select the .hex file

D. The **Enter Password** screen will open, prompting for a password. Refer to Figure 13.5.

1. The password is the **Advanced** password. The Advanced password is a numeric only password. The default advanced password is the number zero (0). If this password is changed by the user, the user should make note of the new password and keep this in a safe place.

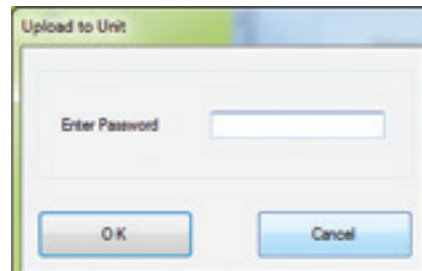


Figure 13.5-Enter the Advanced Password



- E. Select **OK** and the firmware upgrade will begin.
- F. In the **Status** box on the Firmware Upgrade screen, the message **In Progress** will appear. Refer to Figure 13.6.

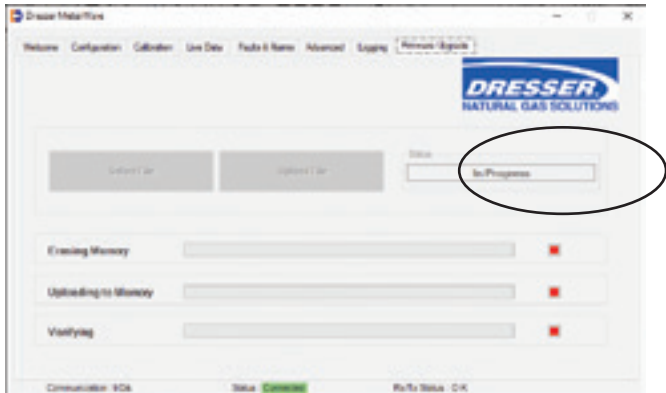


Figure 13.6-MeterWare software showing In Progress status

- G. The software also begins to search for the **BootLoader**, which is necessary to upgrade the firmware. Refer to Figure 13.7.
  - 1. The **Status** area at the bottom of the screen shows progress locating the BootLoader, moving from **Searching** to a **yellow** highlighted message when the device is in range and a **green** highlighted message when located.
- H. Once communication is fully established, the firmware upgrade begins.

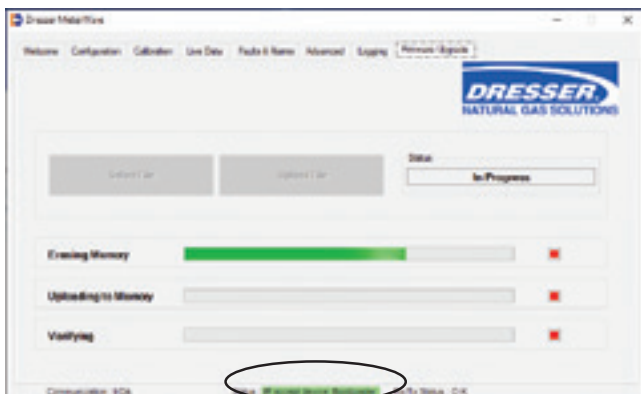


Figure 13.7-Device in Range: BootLoader

### 13.3. Firmware Upgrade Process

- A. There are three status bars, which will move across the screen as each of the three steps is completed (Figure 13.8)
  - 1. Erasing Memory: the current firmware in the unit must be erased.
  - 2. Uploading to Memory: once the previous firmware is erased, the unit is ready to accept the new firmware and begins the process.
  - 3. Verifying: confirms that the new firmware has been uploaded properly
- B. The square to the right of a particular function will change from red to green, confirming that a particular step in the firmware upgrade process has been completed, and the function can move to the next step.

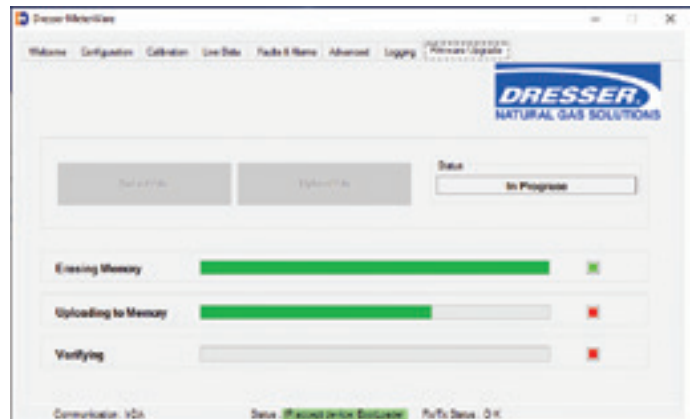


Figure 13.8-Progression of three steps for uploading the new firmware to the unit

- C. When the firmware upgrade is complete, the three squares are green and the screen displays the message **Firmware updated successfully**. (Figure 13.9)

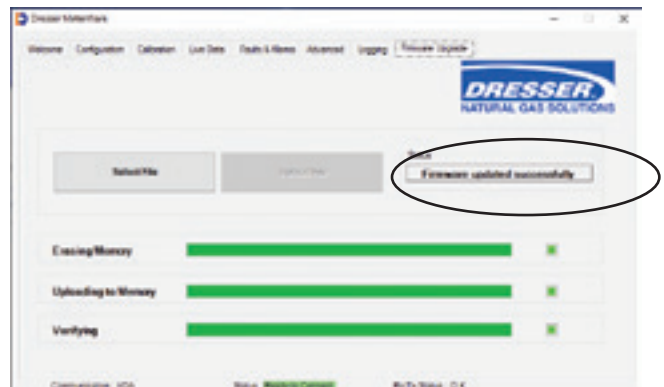


Figure 13.9-Firmware upgrade is complete.

- D. Close the MeterWare software. Re-open and reconnect to begin communication with the unit.

## 14. ETC Specifications

### Physical

- Dimensions:  
Circular Version: 6-3/4 x 5-1/4 x 5-1/4  
AMR Version: 8 x 5-1/4 x 5-1/4
- Weight:  
Circular Version: 2.50 lbs  
AMR Version: 2.95 lbs

### Display

- Capacity Registration – 5, 6, 7, or 8 digit
- Screens – 20 (user selectable)
- Screen scrolling – magnetic switch

### Temperature Measurement System

- Extremely stable Class A, PT1000 RTD
- Range:-40 to 140°F (-40 to 60°C)

### Temperature Accuracy

#### Temperature Reading Accuracy

-40°F to 140°F: +/- 0.9°F (-40°C to 60°C: +/- 0.5°C)

- Computational accuracy: +/- .25% of compensated volume reading
- Total Ambient temperature effect: Less than 0.1°F (0.05°C) over entire temperature range

### Environmental Conditions

- Ambient Temperature Range :-40 to 140°F (-40 to 60°C)
- Ambient Humidity Range: 0 to 100% non-condensing

### Communication

Optical reading port requires IrDA (Infrared) probe and Dresser MeterWare software for:

- Downloads
- Programming
- Firmware upgrades

### Pulse Outputs

- Form A (normally open) outputs
  - Two user-selectable Form A Outputs
  - Output Representation: Compensated, Non-Compensated, Fault or Disabled
  - Pulse Rate: User Scalable (x 1, x 10, x 100 or x 1000 cu.ft.)
  - Pulse Duration: User Scalable (50, 150 or 250 ms)
  - AMR Compatibility: Any Form A pulse collector such as Itron ERT
- Form B (normally Closed) output
  - Dedicated Form B fault/alarm output
  - Output Representation: Fault or Disabled
  - User selectable fault output type:
    - « Continuous: One 500 ms pulse every 30 seconds while fault is present
    - « Latched: Provides a single 500 ms pulse output per each fault and selected alarm
- All pulse outputs are opto-isolated.
- Max applied voltage: 8.2v is the maximum applied voltage the isolation amplifier presents to the opto-isolators.
  - To maintain compliance with CSA certification, use a suitable Intrinsic Safety barrier for a Class 1, Division 1 hazardous area for groups A, B, C and D:
    - « Do not exceed the following input values for the barrier device:
      - Vi=8.2V
      - Ii=10ma
    - « The OUTPUT and power handling capability of a barrier should not exceed:
      - Vout=30V
      - Iout=50ma

### Testing

- 2 minute compensated and non-compensated proving with Dresser Model 5 Transfer Prover
- IRdA (Infrared) communications cable for compensated and non-compensated proving on Model 5 and sonic nozzle provers

### Flow Selection

- Forward
- Reverse
- Forward – Reverse
- Reverse – Forward
- Forward + Reverse

## Alarms

- High Temperature
- Low Temperature
- High Flow Rate
- Low Battery
- Volume Input

## Faults

- Temperature
- Volume
- Low Battery
- Internal Operation
- Volume Sensor Fault
- Power Fault

## Data Logging

- Data Logging – 150 days of hourly logs
- Logged Data – Time, Stamp, Compensated Volume, Non Compensated Volume, Line Temperature, Battery voltage, Faults and Alarms
- Audit Trail – Parameter, Time Stamp, Old Value and New Value
- Data exportable to Microsoft® Excel®

## Power

- Sealed Battery Pack – Lithium Thionyl Chloride Pack with CSA certified protective circuitry
- Voltage Range: 3.0-3.7 V DC
- Average battery life of 20 years
- Battery Access: Field Replaceable
- Battery life remaining indicated in months
- Flash memory for permanent information retention without power

## Warranty

- Four year ETC/ETCA manufacturer's warranty
- Twelve year battery warranty

## Certifications

- CSA: Class 1, Div 1, Group A, B, C and D Certification, to C22.2 No. 213 (pending)
- Meets internationally recognized standards for moisture ingress protection (IP 65 and IP 67)
- Electromagnetic compliance per IEC standards
- Electrostatic discharge compliance per IEC standards

## 15. Warranty

The warranty for Dresser ETC products shall expire four (4) years from delivery, except that software is warranted for ninety (90) days from delivery. Battery packs for the Dresser ETC products have a separate warranty which expires twelve (12) years from delivery. All other terms of the Terms and Conditions for Sale of Products and Services Form ES 104 apply.

Contact factory for the latest revision of Terms and Conditions for Sale of Products and Services Form ES 104.

**Dresser Measurement**  
16240 Port Northwest Drive  
Houston, TX 77041  
T: 1-800-521-1114  
F: 1-800-335-5224

*© 2022 Natural Gas Solutions North America, LLC – All rights reserved. Natural Gas Solutions reserves the right to make changes in specifications and features shown herein, or discontinue the product described at any time without notice or obligation. Contact your Dresser Natural Gas Solutions representative for the most current information. The Dresser Logo and all Trademarks containing the term "Dresser" are the property of Dresser, LLC, a subsidiary of Baker Hughes.*



[www.dresserutility.com](http://www.dresserutility.com)

*Dresser ETC IOM Manual NGS.MI.0055d*

10.22